

	<h1 style="margin: 0;">AP1150</h1> <h2 style="margin: 0;">200mA Output, High PSRR, Low Noise LDO Regulator Fixed Output Voltage Type</h2>
---	---

1. General Description

The AP1150 is a low dropout linear regulator with On/Off control, which can supply 200mA load current. The output voltage, trimmed with high accuracy, is available from 1.3 to 9.5V in 0.1V steps, and the output capacitor is available to use a small 0.1 μ F ceramic capacitor ($1.8V \leq V_{OUT}$).

The AP1150 has a built-in over-current protection and thermal shutdown protection circuit, and is possible to provide two types of package, the AP1150ADSXX is the SOT23-5 package and the AP1150AEUXX is the PLP1822-6 package with Exposed Pad.

2. Features

- | | |
|---|---|
| • Operating Temperature Range | -40 to 85°C |
| • Operating Voltage Range | 2.1 to 14.0V |
| • Output Current | 200mA |
| • Operating Voltage Range | 1.3 to 9.5V |
| • Output Voltage Precision | $\pm 1.5\%$ or $\pm 50mV$ |
| • Dropout Voltage | 120mV at $I_{OUT}=100mA$ |
| • Ripple Rejection | 80dB at 1kHz |
| • Available very low noise application | |
| • Available to use a small ceramic capacitor | |
| • On/Off control (High active) | |
| • Built-in Short circuit protection, thermal shutdown | |
| • Package | AP1150ADSXX : SOT23-5
AP1150AEUXX : PLP1822-6 (with Exposed Pad) |

3. Applications

- | | |
|---|---|
| • RF Power Supplies | PLL, VCO, Mixer, LNA |
| • Low Noise Image Sensor Unit | Digital Still Camera |
| • High Speed/High Precision A-D, D-A, Amplifier | Audio Equipment
Medical Equipment
Instrumentation |
| • Precision Power Supplies | |
| • Post Regulator for Switching Supplies | Car Infotainment |

4. Table of Contents

1. General Description	1
2. Features	1
3. Applications	1
4. Table of Contents	2
5. Block Diagram	3
6. Ordering Information	4
7. Pin Configurations and Functions	5
■ Pin Configurations	5
■ Functions	5
8. Absolute Maximum Ratings	7
9. Recommended Operating Conditions	7
10. Electrical Characteristics	8
■ Electrical Characteristics of $T_a=T_j=25^{\circ}\text{C}$	8
■ Electrical Characteristics of $T_a=-40^{\circ}\text{C}$ to 85°C	10
11. Description	12
11.1 DC Characteristics	12
11.2 DC Temperature Characteristics	14
11.3 AC Characteristics	15
11.4 About stable operation	19
11.5 On/Off Control	21
11.6 Noise Pass Terminal	21
11.7 Notes on output terminal (V_{OUT}) to GND short-circuit evaluation	22
11.8 Thermal Resistance and Power Dissipation	22
12. Definition of term	24
13. Recommended External Circuit	25
■ Recommended External Circuit	25
■ Recommended Layout	25
14. Package	26
· SOT23-5	26
· PLP1822-6	26
15. Revise History	27
IMPORTANT NOTICE	28

5. Block Diagram

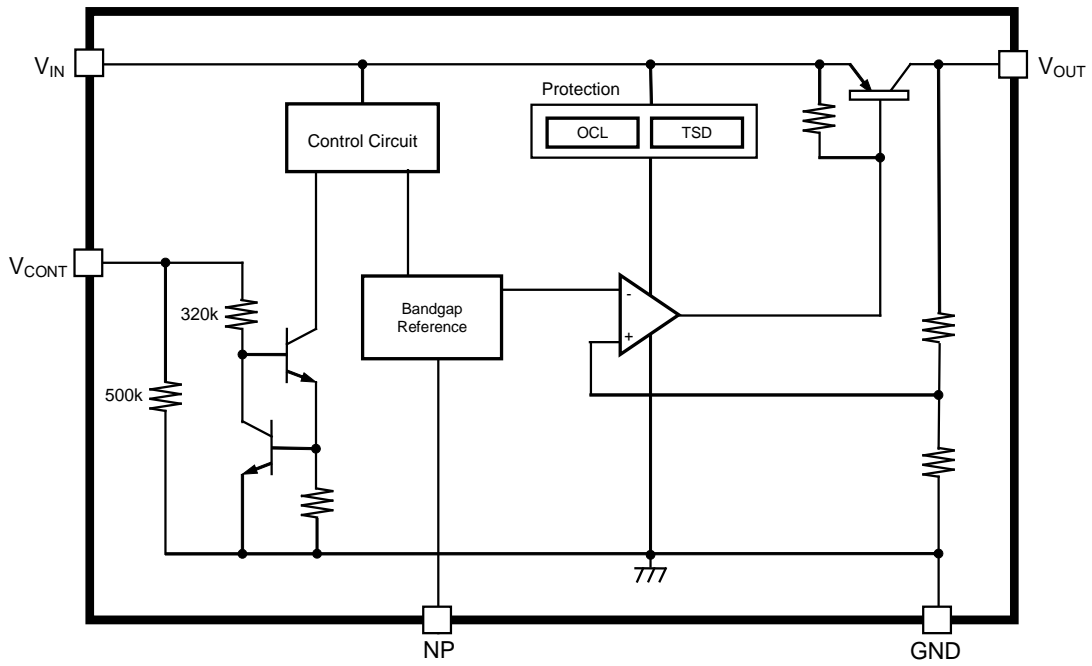

Figure 1. Block Diagram

6. Ordering Information

AP1150ADSXX	Ta = -40 to 85°C	SOT23-5
AP1150AEUXX	Ta = -40 to 85°C	PLP1822-6

• **Output Voltage Code**

Please check [Table 1](#) for output voltage code. Please consult our distributor for consideration other than the output voltage lineup of [Table 1](#).

AP1150ADSXX

AP1150AEUXX

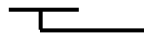
 Output voltage code

 Output voltage code

Table 1. Output Voltage Code

XX	V _{OUT}	XX	V _{OUT}	XX	V _{OUT}	XX	V _{OUT}
15	1.5	30	3.0	40	4.0	50	5.0
18	1.8	33	3.3	45	4.5	54	5.4

7. Pin Configurations and Functions

Pin Configurations

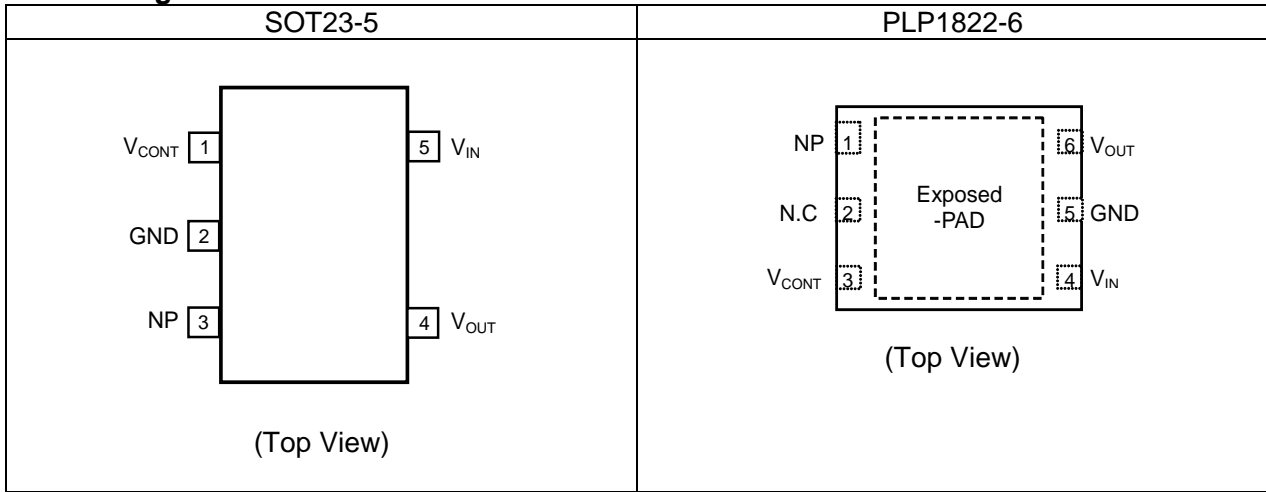

Functions

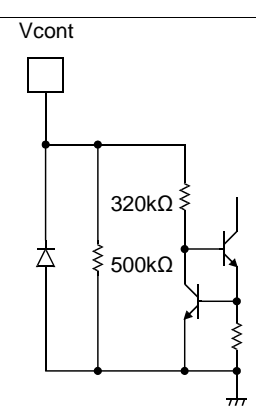
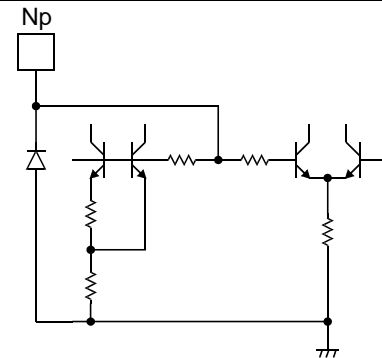
Pin No.		Pin Description	Internal Equivalent Circuit	Description
SOT23 -5	PLP1822 -6			
1	3	V_{CONT}		<p>On/Off Control Terminal</p> <p>The pull-down resistor (500kΩ) is built-in.</p>
2	5	GND		GND Terminal
3	1	NP		<p>Noise Bypass Terminal</p> <p>Connect a bypass capacitor between GND.</p>

Pin No.		Pin Description	Internal Equivalent Circuit	Description
SOT23 -5	PLP1822 -6			
4	6	V _{OUT}		Output Terminal
5	4	V _{IN}		Input Terminal
-	2	N.C		No Connection Terminal
-	Exposed Pad	-		Ground Terminal Heat dissipation pad Exposed Pad must be connected to GND.

8. Absolute Maximum Ratings

Parameter	Symbol	min	max	Unit	Condition	
Supply Voltage	$V_{CC(MAX)}$	-0.4	16	V		
Reverse Bias Voltage	$V_{REV(MAX)}$	-0.4	6	V	$V_{OUT(TYP)} \leq 2.0V$	
		-0.4	12	V	$2.1V \leq V_{OUT(TYP)}$	
NP Terminal Voltage	$V_{NP(MAX)}$	-0.4	5	V		
V_{CONT} Terminal Voltage	$V_{CONT(MAX)}$	-0.4	16	V		
Junction Temperature	T_j	-	150	°C		
Storage Temperature Range	T_{STG}	-55	150	°C		
Power Dissipation	SOT23-5	P_D	-	500	mW	(Note 1)
	PLP1822-6		-	1500	mW	(Note 1)

Note 1. A 4-layer JEDEC51-3 compliant board is used.
 If the temperature exceeds 25°C, be sure to derate at [Figure 2](#).
 SOT23-5 : $\theta_{JA} = 250^\circ\text{C/W}$
 PLP1822-6 : $\theta_{JA} = 83^\circ\text{C/W}$

WARNING: The maximum ratings are the absolute limitation values with the possibility of the IC breakage. When the operation exceeds this standard quality cannot be guaranteed.

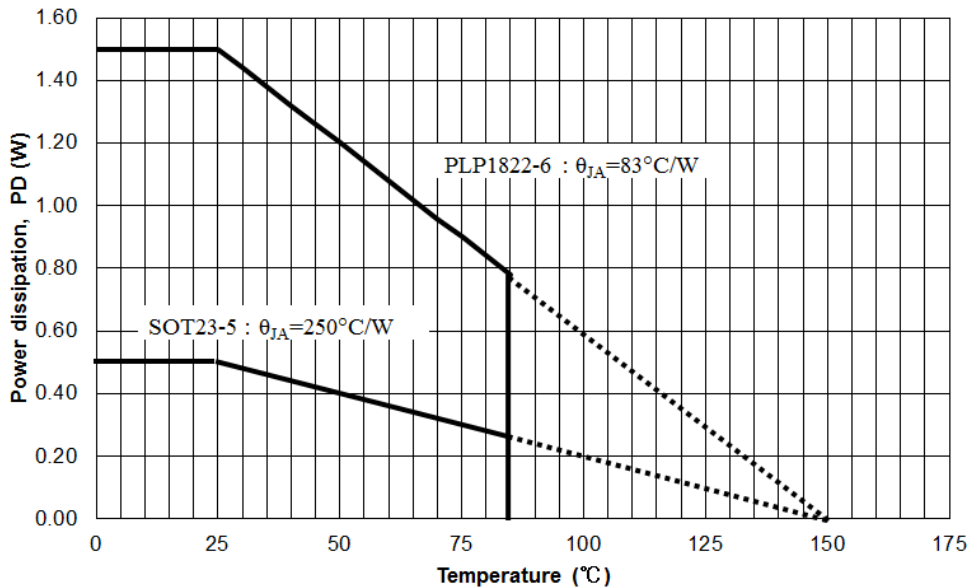

Figure 2. Maximum Power Dissipation

9. Recommended Operating Conditions

Parameter	Symbol	min	typ	max	Unit	Condition
Operating Temperature Range	T_a	-40	-	85	°C	
Operating Voltage Range	V_{OP}	2.1	-	14	V	
Output Voltage Range	V_{OUT}	1.3	-	9.5	V	

10. Electrical Characteristics

■ **Electrical Characteristics of Ta=Tj=25°C**

The parameters with min or max values will be guaranteed at Ta=Tj=25°C.

($V_{IN}=V_{OUT(TYP)}+1V, V_{CONT}=1.8V, T_a=T_j=25^\circ C$, unless otherwise specified.)

Parameter	Symbol	Condition	min	typ	max	Unit
Output Voltage	V_{OUT}	$I_{OUT}=5mA$	(Table 2)			V
Line Regulation	LinReg	$\Delta V_{IN}=5V$	-	0.0	5.0	mV
Load Regulation	LoaReg	$I_{OUT}=5mA$ to 100mA	(Table 2)			mV
		$I_{OUT}=5mA$ to 200mA				mV
Dropout Voltage (Note 2)	V_{DROP}	$I_{OUT}=50mA$	-	80	140	mV
		$I_{OUT}=100mA$	-	120	210	mV
		$I_{OUT}=180mA$ ($2.1V \leq V_{OUT} \leq 2.3V$)	-	230	350	mV
		$I_{OUT}=200mA$ ($2.4V \leq V_{OUT}$)	-	200	350	mV
Maximum Output Current (Note 3)	$I_{OUT(MAX)}$	$V_{OUT}=V_{OUT(TYP)} \times 0.9$	240	320	-	mA
Output Short-Circuit Current (Note 3)	I_{SHORT}		-	360	-	mA
Quiescent Current	I_Q	$I_{OUT}=0mA$	-	63	100	μA
Standby Current	$I_{STANDBY}$	$V_{CONT}=0V$	-	0.0	0.1	μA
Ground Terminal Current	I_{GND}	$I_{OUT}=50mA$	-	1.0	1.8	mA
Control Terminal (V_{CONT})						
V_{CONT} Terminal Current	I_{CONT}	$V_{CONT}=1.8V$	-	5.0	15.0	μA
V_{CONT} Terminal Voltage	V_{CONT}	V_{OUT} ON state	1.8	-	-	V
		V_{OUT} OFF state	-	-	0.35	V

Note 2. For $V_{OUT} \leq 2.0V$, no regulations.

Note 3. The maximum output current is limited by power dissipation.

Table 2. Output Voltage & Load Regulation

Part Number	Output Voltage			Load Regulation			
				$I_{OUT} = 100\text{mA}$		$I_{OUT} = 200\text{mA}$	
	min	typ	max	typ	max	typ	max
	V	V	V	V	V	mV	V
AP1150ADS15 AP1150AEU15	1.450	1.500	1.550	10	23	21	49
AP1150ADS18 AP1150AEU18	1.750	1.800	1.850	10	24	22	51
AP1150ADS30 AP1150AEU30	2.950	3.000	3.050	11	27	26	61
AP1150ADS31 AP1150AEU31	3.050	3.100	3.150	12	27	26	62
AP1150ADS33 AP1150AEU33	3.250	3.300	3.350	12	28	27	64
AP1150ADS40 AP1150AEU40	3.940	4.000	4.060	13	30	29	69
AP1150ADS45 AP1150AEU45	4.432	4.500	4.568	13	31	31	73
AP1150ADS50 AP1150AEU50	4.925	5.000	5.075	14	32	33	78
AP1150ADS54 AP1150AEU54	5.319	5.400	5.481	14	33	34	81

■ Electrical Characteristics of Ta=-40°C to 85°C

The parameters with min or max values will be guaranteed at Ta=-40°C to 85°C.

($V_{IN}=V_{OUT(TYP)}+1V, V_{CONT}=1.8V, T_a=-40$ to 85°C , unless otherwise specified.)

Parameter	Symbol	Condition	min	typ	max	Unit
Output Voltage	V_{OUT}	$I_{OUT}=5\text{mA}$	(Table 3)			V
Line Regulation	LinReg	$\Delta V_{IN}=5\text{V}$	-	0.0	8.0	mV
Load Regulation	LoaReg	$I_{OUT}=5\text{mA}$ to 100mA	(Table 3)			mV
		$I_{OUT}=5\text{mA}$ to 200mA				mV
Dropout Voltage (Note 4)	V_{DROP}	$I_{OUT}=50\text{mA}$	-	80	180	mV
		$I_{OUT}=100\text{mA}$	-	120	270	mV
		$I_{OUT}=180\text{mA}$ ($2.2\text{V} \leq V_{OUT} \leq 2.3\text{V}$)	-	230	390	mV
		$I_{OUT}=200\text{mA}$ ($2.4\text{V} \leq V_{OUT}$)	-	200	390	mV
Maximum Output Current (Note 5)	$I_{OUT(MAX)}$	$V_{OUT}=V_{OUT(TYP)} \times 0.9$	220	320	-	mA
Output Short-Circuit Current (Note 5)	I_{SHORT}		-	360	-	mA
Quiescent Current	I_Q	$I_{OUT}=0\text{mA}$	-	63	120	μA
Standby Current	$I_{STANDBY}$	$V_{CONT}=0\text{V}$	-	0.0	0.5	μA
Ground Terminal Current	I_{GND}	$I_{OUT}=50\text{mA}$	-	1.0	2.2	mA
Control Terminal (V_{CONT})						
V_{CONT} Terminal Current	I_{CONT}	$V_{CONT}=1.8\text{V}$	-	5.0	15.0	μA
V_{CONT} Terminal Voltage	V_{CONT}	V_{OUT} ON state	1.8	-	-	V
		V_{OUT} OFF state	-	-	0.35	V

Note 4. For $V_{OUT} \leq 2.1\text{V}$, no regulations.

Note 5. The maximum output current is limited by power dissipation.

Table 3. Output Voltage & Load Regulation

Part Number	Output Voltage			Load Regulation			
				$I_{OUT} = 100\text{mA}$		$I_{OUT} = 200\text{mA}$	
	min	typ	max	typ	max	typ	max
	V	V	V	V	V	mV	V
AP1150ADS15 AP1150AEU15	1.420	1.500	1.580	10	27	21	63
AP1150ADS18 AP1150AEU18	1.720	1.800	1.880	10	28	22	63
AP1150ADS30 AP1150AEU30	2.920	3.000	3.080	11	32	26	83
AP1150ADS33 AP1150AEU33	3.217	3.300	3.383	12	33	27	88
AP1150ADS40 AP1150AEU40	3.900	4.000	4.100	13	36	29	100
AP1150ADS45 AP1150AEU45	4.387	4.500	4.613	13	38	31	109
AP1150ADS50 AP1150AEU50	4.875	5.000	5.125	14	40	33	117
AP1150ADS54 AP1150AEU54	5.265	5.400	5.535	14	41	34	124

11. Description

11.1 DC Characteristics

Line Regulation

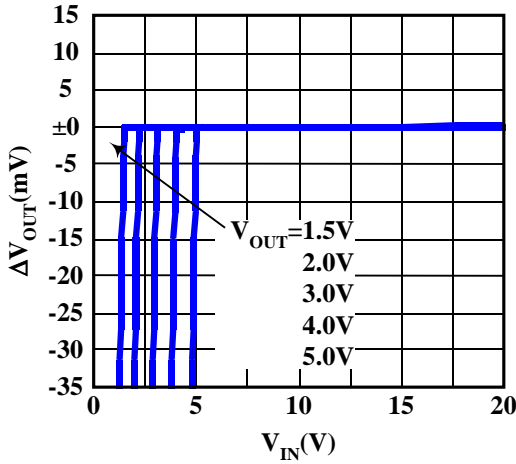

Load Regulation

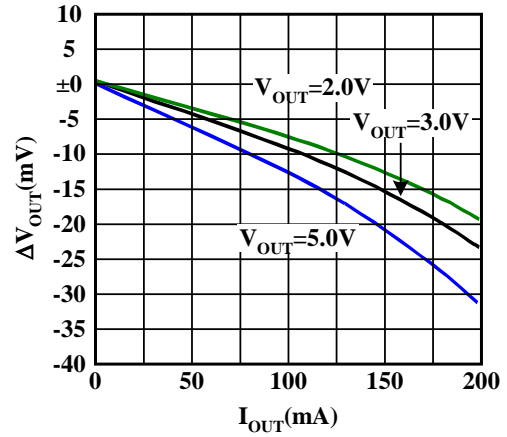

Regulation Point ($2.1V \leq V_{OUT}(typ)$)

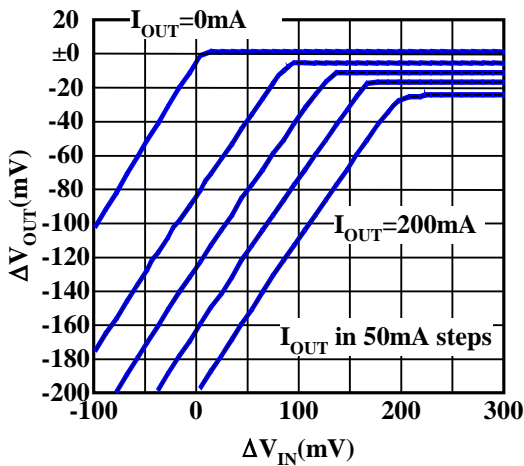

Dropout Voltage vs Output Current

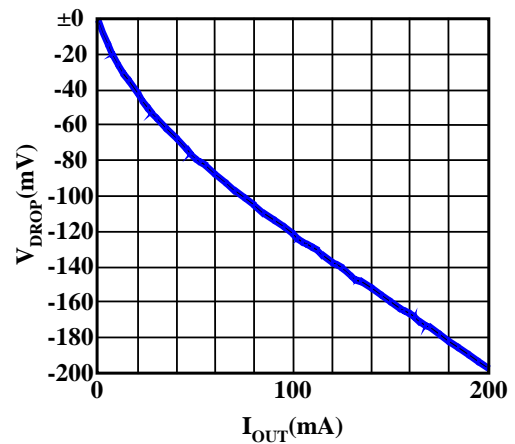

Output Short-Circuit Current

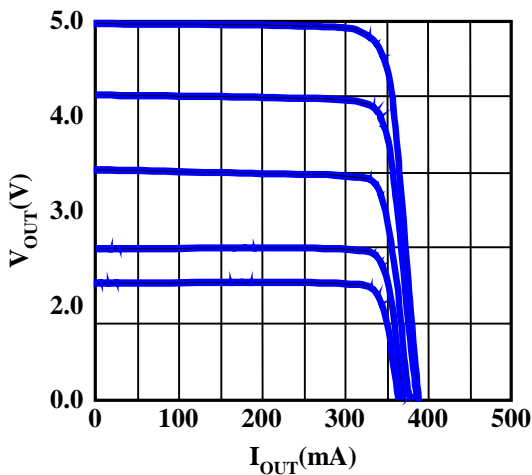

Reverse Bias Current

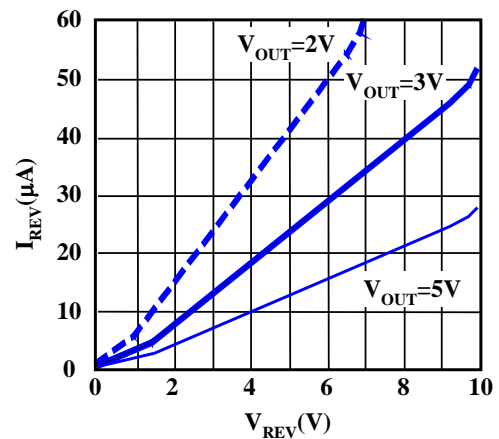

■ CONT Terminal Current and On/Off Point

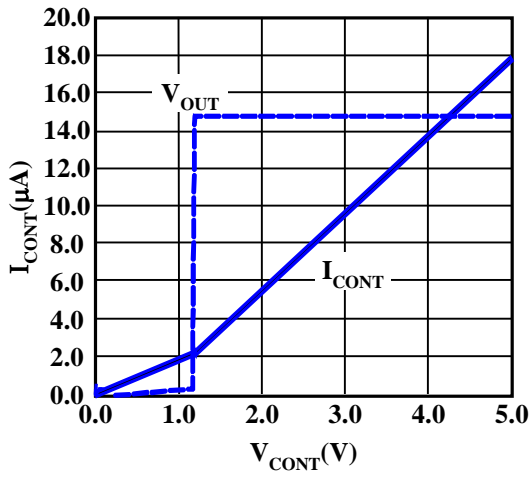

■ Quiescent Current vs Output Current

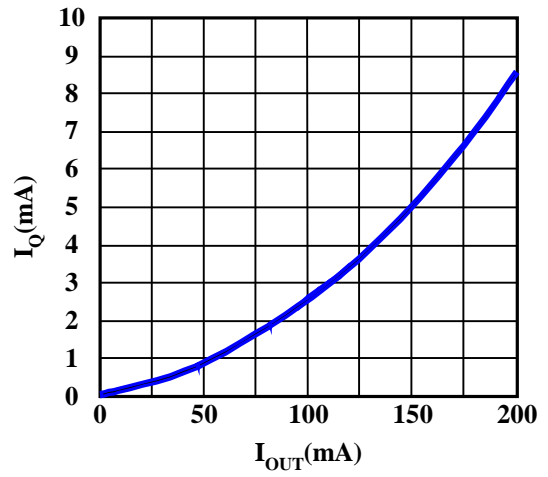

■ Standby Current ($V_{CONT}=0V$)

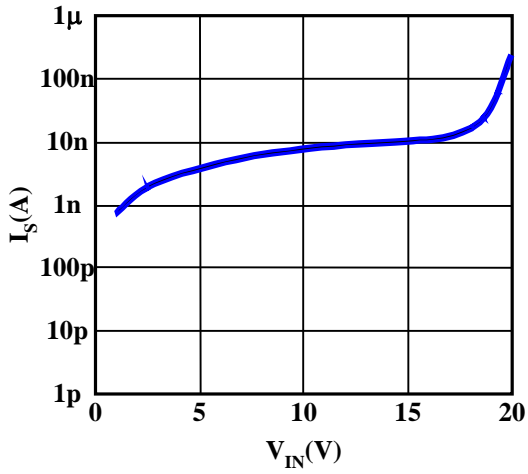

11.2 DC Temperature Characteristics

■ Maximum Output Current

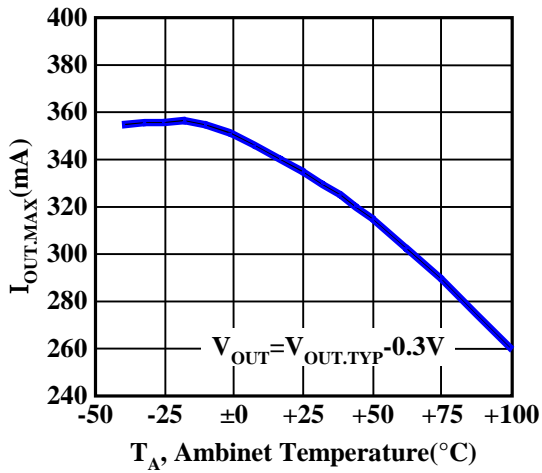

■ Quiescent Current

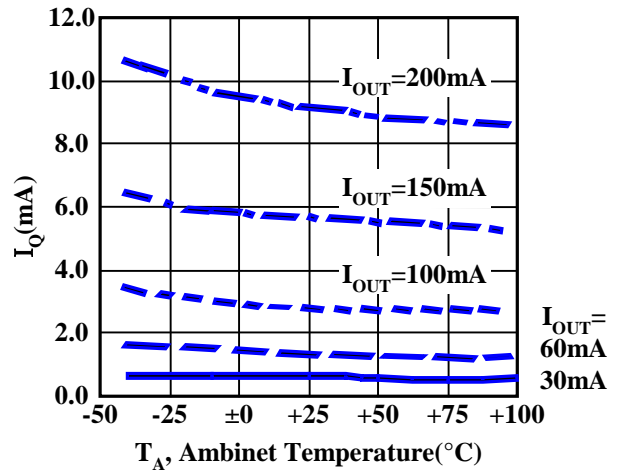

■ Dropout Voltage

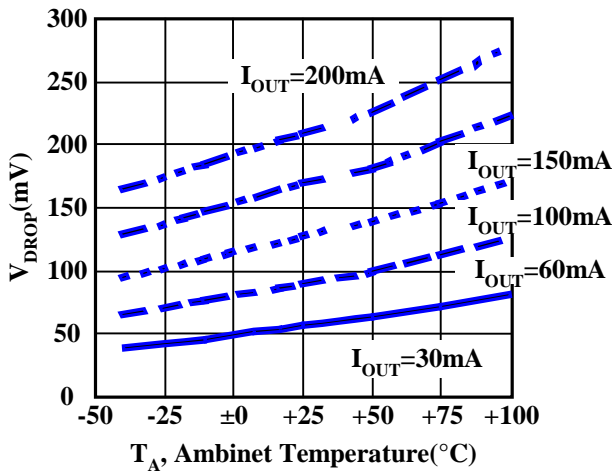

■ CONT Terminal Current

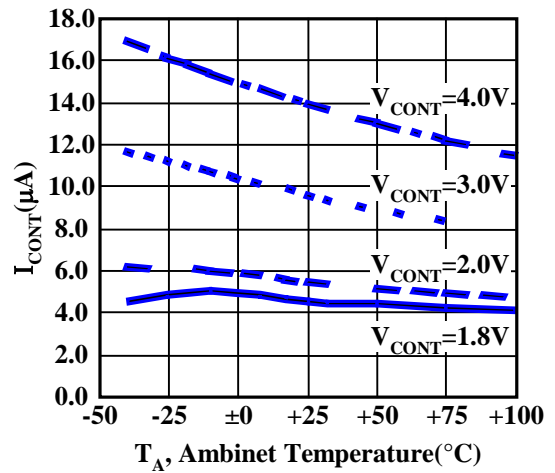

■ CONT Terminal On/Off point

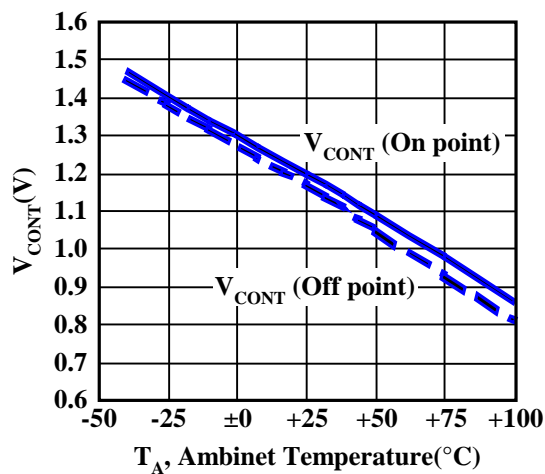

11.3 AC Characteristics

•Ripple Rejection

The ripple rejection characteristic depends on the characteristic and the capacity value of the capacitor connected with the output side. The ripple rejection characteristic of 50kHz or more changes greatly in the capacitor on the output side and PCB pattern. Please confirm stability if necessary while operated.

■ $C_L=0.22\mu\text{F}$, $1.0\mu\text{F}$: MLCC

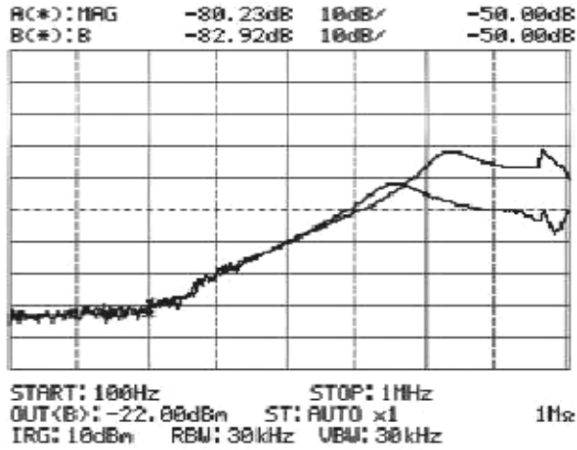

Common conditions are shown as follows:

- $V_{IN}=5.0\text{V}$ ($V_{IN}=V_{OUT(TYP)}+2\text{V}$)
- $V_{OUT}=3.0\text{V}$
- $I_{OUT}=10\text{mA}$
- $V_R=500\text{mV}_{P-P}$
- $f=100\text{Hz}$ to 1MHz
- $C_{NP}=0.01\mu\text{F}$

■ $C_L = 1.0\mu\text{F}$, $10\mu\text{F}$: MLCC

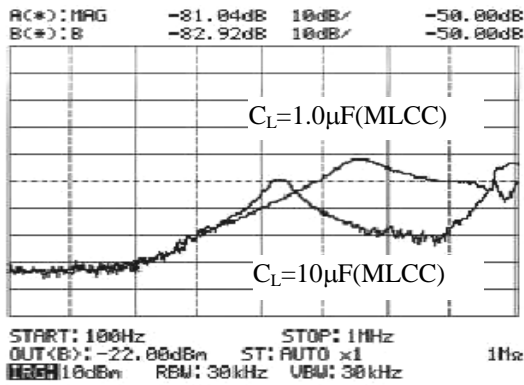

■ $C_{NP}=0.1\mu\text{F}$, $0.01\mu\text{F}$: MLCC

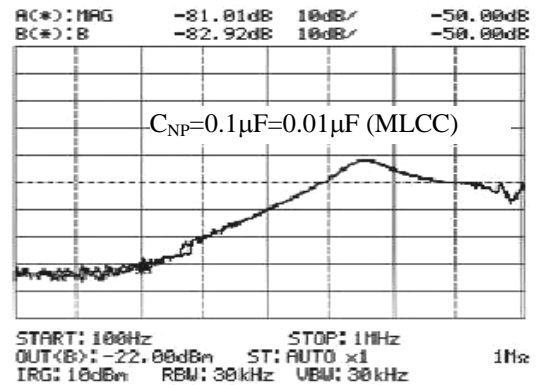

• Output Noise

It is more effective if it increases the C_{NP} than to increase the C_L is the case that require low noise. C_{NP} capacity is recommended 0.01 μ F to 0.1 μ F. Amount of noise will be a lot higher output voltage products.

■ Output Noise vs. Noise Pass Capacitance
 $I_{OUT}=30mA$

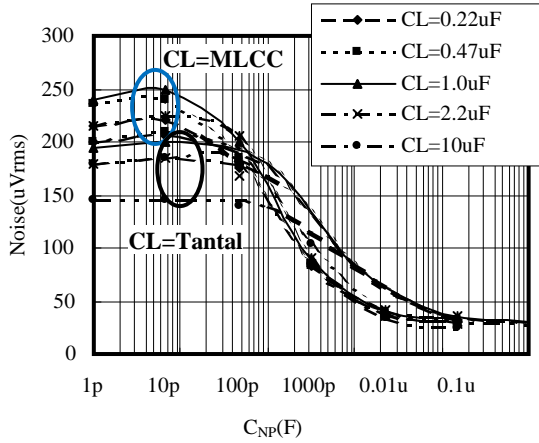

■ Output Noise vs. Output Voltage
 $I_{OUT}=30mA, C_{NP}=0.01\mu F, C_L=1.0\mu F$ (Tantal)

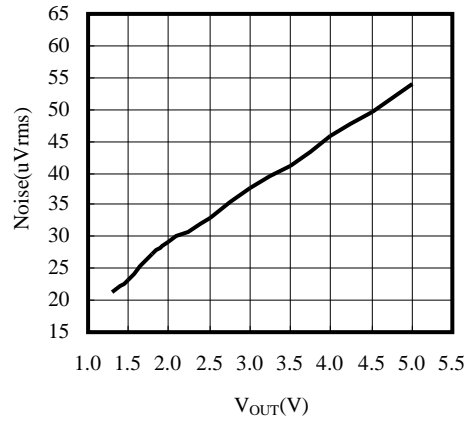

■ Output Noise vs. Output Current
 $C_L=Tantal, C_{NP}=0.01\mu F$

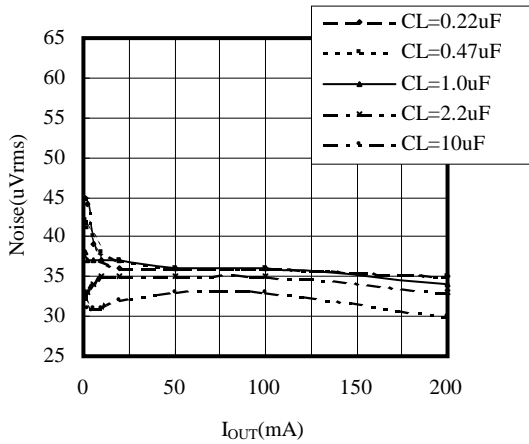

■ Output Noise vs. Output Current
 $C_L=MLCC, C_{NP}=0.01\mu F$

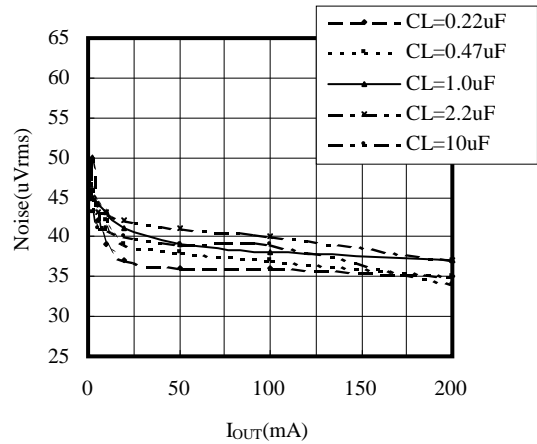

■ Output Noise Level(1/f) vs. Frequency
 $I_{OUT}=10mA, C_{IN}=10\mu F, C_L=0.22\mu F$ (MLCC)

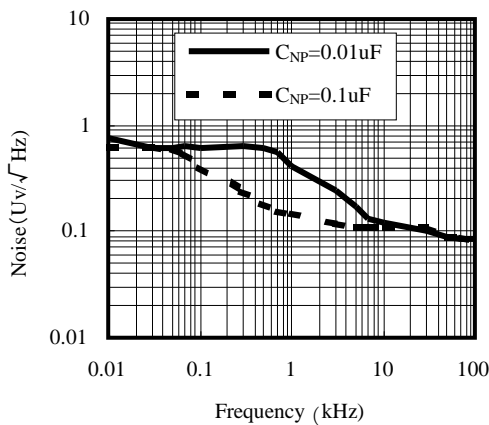

•On/Off Transient

The rise time of the IC will be slow and C_L , C_{NP} is large. Rise time is dependent C_L , on the C_{NP} , fall time is dependent on the C_L .

- Parameter: $C_L=0.22\mu\text{F}$, $2.2\mu\text{F}$, $10\mu\text{F}$
- Fixed: $C_{NP}=0.001\mu\text{F}$

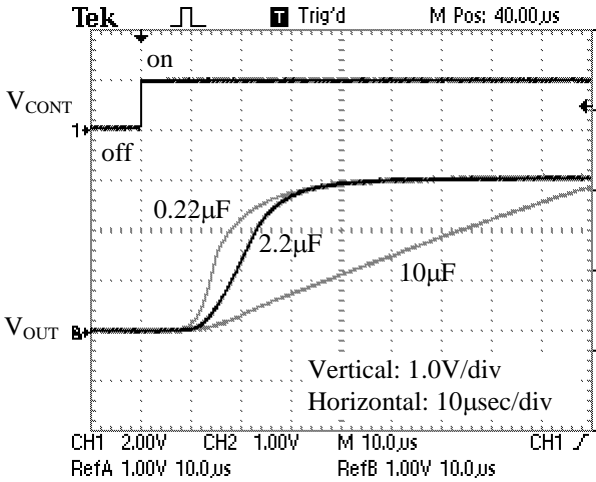

Common conditions are shown as follows:

- $V_{CONT}=0\text{V} \leftrightarrow 2.0\text{V}$ @ $f=100\text{Hz}$
- $I_{OUT}=30\text{mA}$
- $C_{IN}=1.0\mu\text{F}$
- $C_L=2.2\mu\text{F}$
- $C_{NP}=0.001\mu\text{F}$

- Parameter: $C_{NP}=100\text{pF}$, $0.001\mu\text{F}$, $0.01\mu\text{F}$
- Fixed: $C_L=2.2\mu\text{F}$

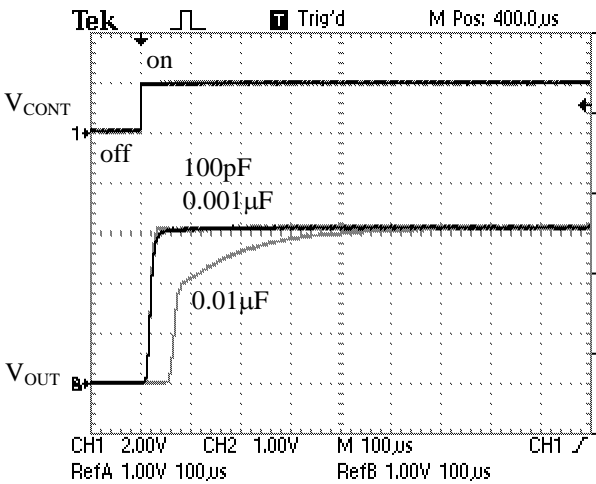

- Parameter: $C_{NP}=0.001\mu\text{F}$, $0.01\mu\text{F}$, $0.1\mu\text{F}$
- Fixed: $C_L=2.2\mu\text{F}$

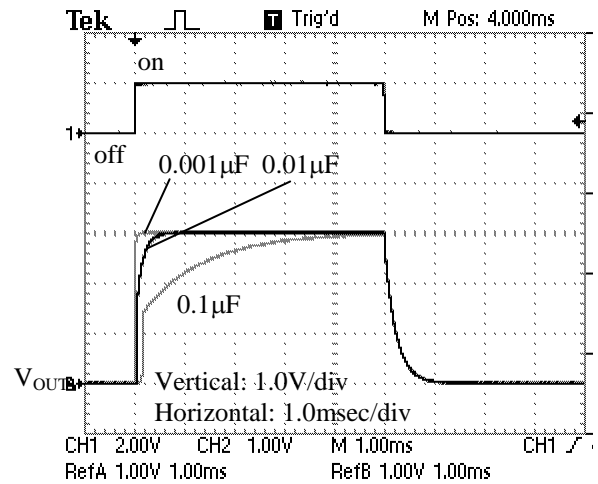

• Load Transient

IC can improve the load change to keep some flow of load current. When there is a fast large current change, please increase the load side capacitor. It can reduce the voltage fluctuation.

■ $I_{OUT}=5\text{mA} \leftrightarrow 35\text{mA}$

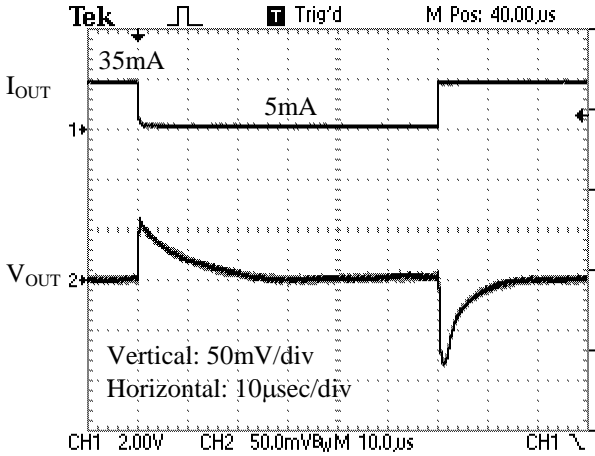

Common conditions are shown as follows:

$V_{CONT}=2.0\text{V}$
 $C_{IN}=1.0\mu\text{F}$
 $C_L=2.2\mu\text{F}$
 $C_{NP}=0.001\mu\text{F}$

■ Parameter: $C_L = 0.22\mu\text{F}, 2.2\mu\text{F}, 10\mu\text{F}$
 Fixed: $C_{NP}=0.001\mu\text{F}$

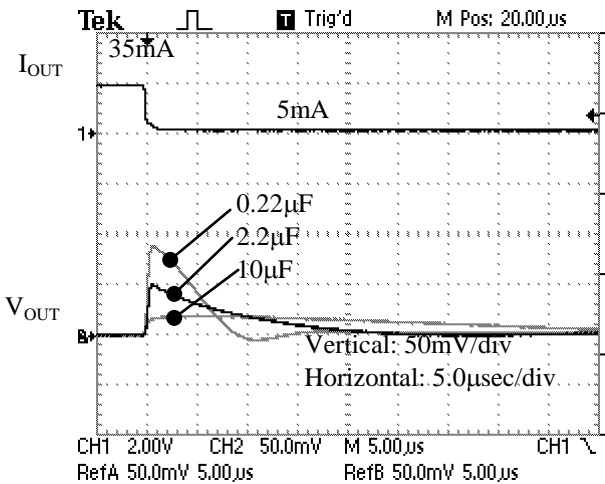

■ Parameter: $C_L = 0.22\mu\text{F}, 2.2\mu\text{F}, 10\mu\text{F}$
 Fixed: $C_{NP}=0.001\mu\text{F}$

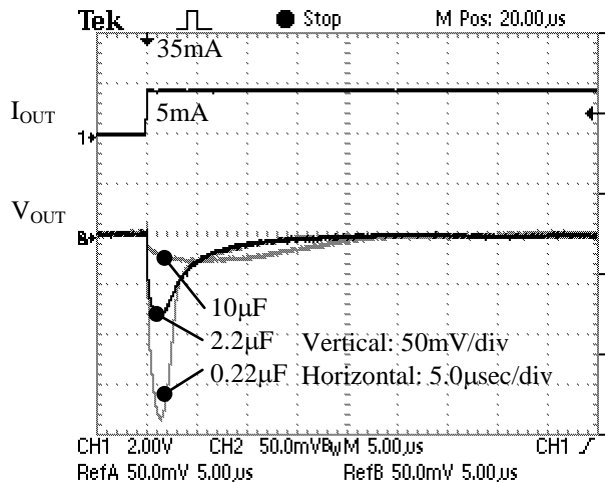

■ $I_{OUT}=30\text{mA} \rightarrow 0\text{mA}, 35\text{mA} \rightarrow 5\text{mA}$

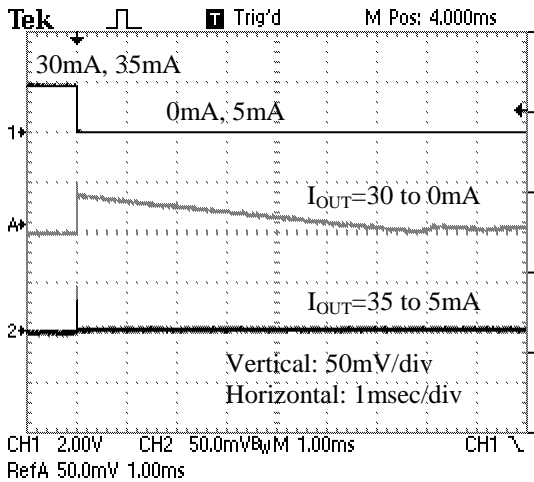

■ $I_{OUT}=0\text{mA} \rightarrow 30\text{mA}, 5\text{mA} \rightarrow 35\text{mA}$

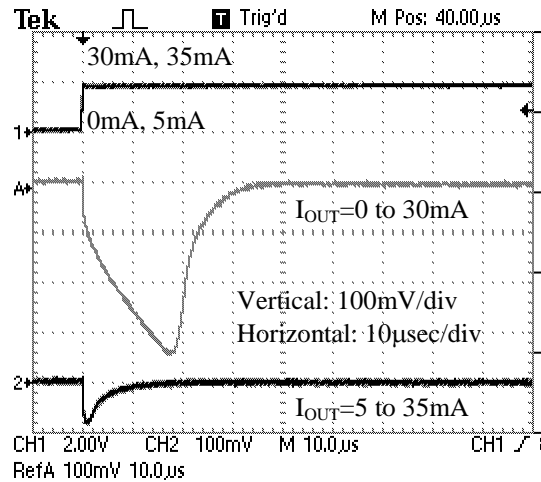

• Line Transient

■ $V_{IN} = V_{OUT(TYP)} + 1.0V \leftarrow \rightarrow +2.0V$
 $I_{OUT} = 30mA, V_{CONT} = 1.8V, C_{IN} = 1.0\mu F, C_L = 2.2\mu F,$
 $C_{NP} = 0.001\mu F$

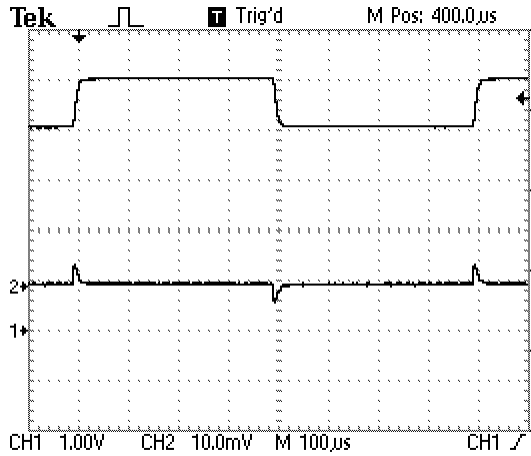

■ $C_L = 0.22\mu F, 2.2\mu F, 10\mu F$
 $C_{NP} = 0.001\mu F$

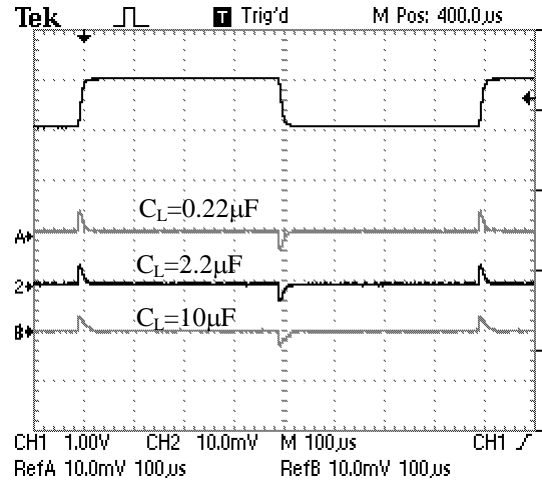

■ $C_{NP} = 0.001\mu F, 0.01\mu F, 0.1\mu F$
 $C_L = 2.2\mu F$

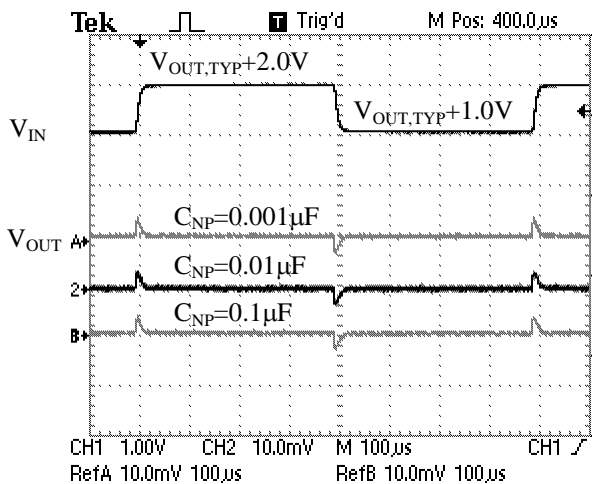

11.4 About stable operation

AP1150 is required for input and output capacitors in order to maintain the regulator's loop stability.

• Input Capacitor (C_{IN})

The input capacitor is necessary when the battery is discharged, the power supply impedance increases, or the line distance to the power supply is long. This capacitor might be necessary on each individual IC even if two or more regulator ICs are used. It is not possible to determine this indiscriminately. Please confirm the stability while mounted.

The recommended value is $C_{IN} = 1.0\mu F$.

• Output Capacitor (C_L)

Operation is stabilized by $0.1\mu F$ ($V_{OUT} \geq 2.0V$) the output side capacitor (C_L). Without taking into account the ESR if C_L is equal to or greater than $0.1\mu F$ in the entire operating temperature range, it can also be used tantalum capacitor not only the ceramic capacitor.

However, since there are variations in the capacity component, can only capacity, please use larger. And large capacitance value as the output noise and ripple noise is reduced small, furthermore, also improves the response to further output side load fluctuation. The IC does not damage by increasing the capacity. In addition, since the low output voltage product is easier to be oscillation, please use or tantalum capacitor to increase the C_L capacity. More of the tantalum capacitor can be obtained the same stability with a smaller value. This serves as the ESR of the tantalum capacitor damping resistance, are considered IC to a more stable operation. The recommended value is $C_{IN} = 1.0\mu F$.

Figure 3 means that IC stable operation with a ceramic capacitor of 0.1uF except for the small current region. In the low voltage and low current region does not stable operation is necessary to increase the capacity.

Please select the optimum output capacitor by using voltage and current used. The output side capacitor (C_L) is stable operating larger. (Stable operation area will spread). Please use only the large capacity can be.

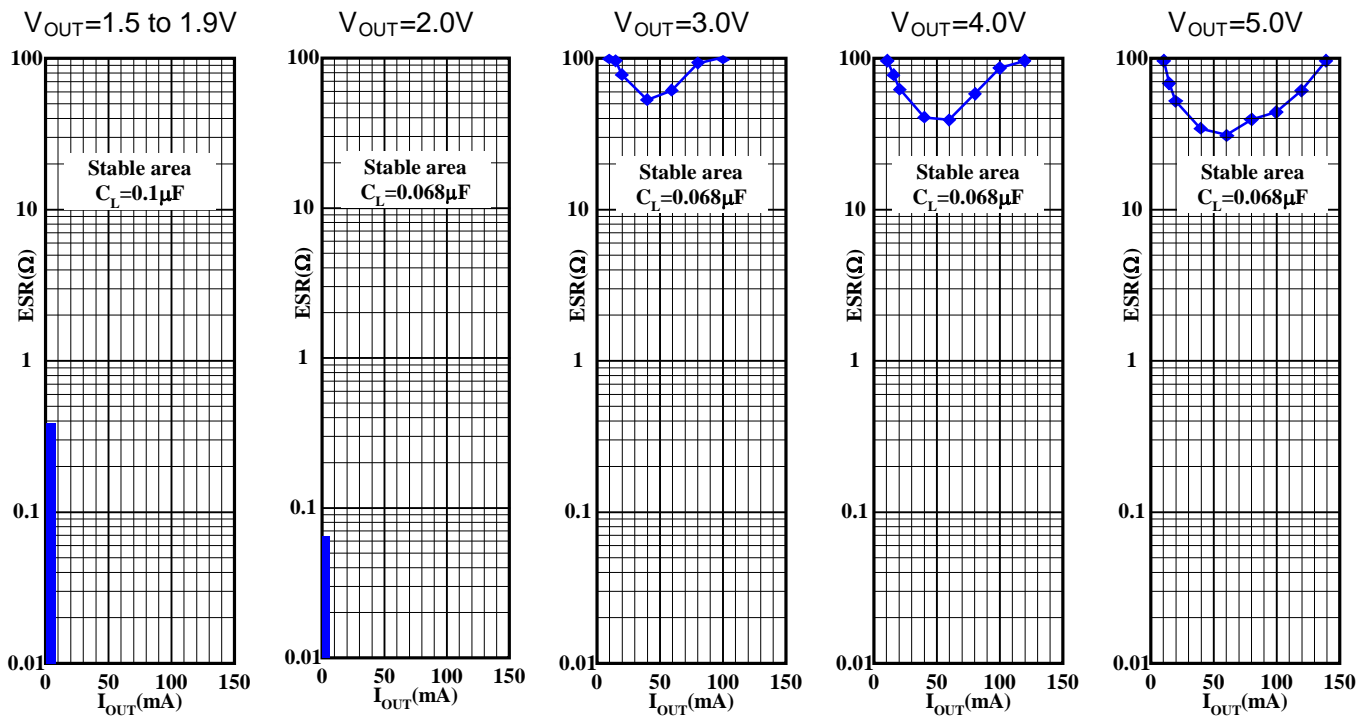

All stable: $C_L \geq 0.22\mu F$

All stable: $C_L \geq 0.1\mu F$

Figure 3. Stable operation area vs. voltage, current, and ESR

Note 6. Capacitor product was used in the evaluation

Kyocera: CM05B104K10AB, CM05B224K10AB, CM105B104K16A, CM105B224K16A, CM21B225K10A

Murata: GRM36B104K10, GRM42B104K10, GRM39B104K25, GRM39B224K10, GRM39B105K6.3

• **Bias voltage and temperature characteristics of the ceramic capacitor**

Generally, a ceramic capacitor has both a temperature characteristic and a voltage characteristic. Please consider both characteristics when selecting the part. The B curves are the recommend characteristics.

■ Capacitance versus Voltage

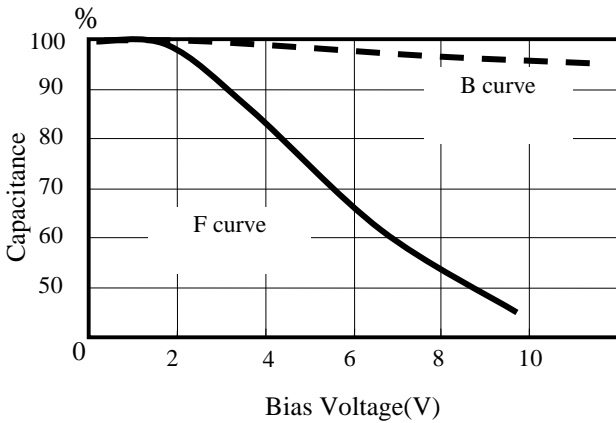

■ Capacitance versus Ambient Temperature

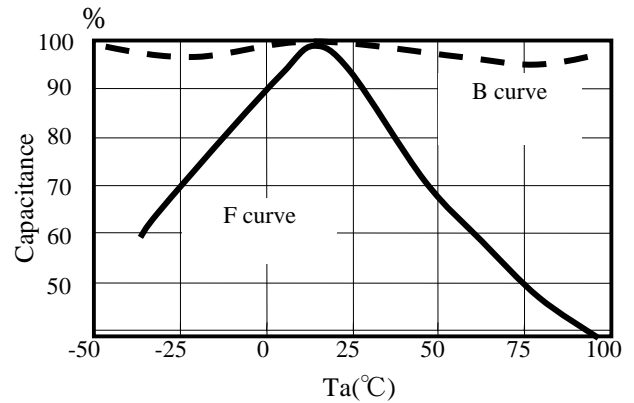

11.5 On/Off Control

It is recommended to turn the regulator off when the circuit following the regulator is non-operating. A design with little electric power loss can be implemented. We recommend the use of the on/off control of the regulator without using a high side switch to provide an output from the regulator. A highly accurate output voltage with low voltage drop is obtained. Because the control current is small, it is possible to control it directly by CMOS logic. The pull-down resistor (500kΩ) is built-in.

Table 4. Control terminal voltage and operating state

Control terminal voltage (V_{CONT})	Status
$V_{CONT} > 1.8V$	ON
$V_{CONT} < 0.35V$	OFF

The Figure 4 is multiple regulators being controlled by a single On/Off control signal. There is fear of overheating, because the power loss of the low voltage side IC (AP1150ADS20) is large. The series resistor (R) is put in the input line of the low output voltage regulator in order to prevent over-dissipation. The voltage dropped across the resistor reduces the large input-to-output voltage across the regulator, reducing the power dissipation in the device. When the thermal sensor works, a decrease of the output voltage, oscillation, etc. may be observed.

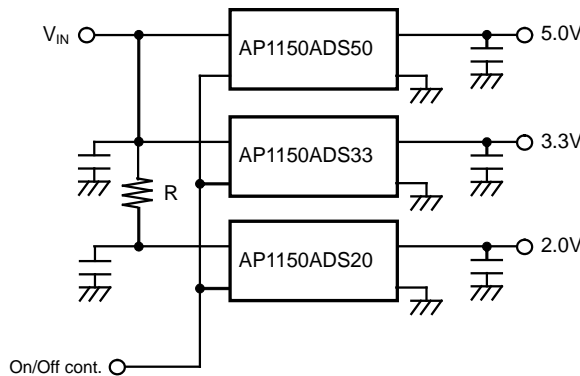

Figure 4. Parallel-Connected On/Off Control

11.6 Noise Pass Terminal

The noise and the ripple rejection characteristics depend on the capacitance on the Np terminal. The ripple rejection characteristic of the low frequency region improves by increasing the capacitance of C_{NP} . A standard value is $C_{NP}=0.001\mu F$. Increase C_{NP} in a design with important output noise and ripple rejection requirements. The IC will not be damaged if the capacitor value is increased. The On/Off

switching speed changes depending on the NP terminal capacitance. The switching speed slows when the capacitance is large.

11.7 Notes on output terminal (V_{OUT}) to GND short-circuit evaluation

The resonance phenomenon due to stick to the output terminal C_L (C component) and the short-circuit line (L component), the output terminal will become a negative potential. Output terminal parasitic transistor operates in the IC enters the minus side, leads to the worst case burning for packages that latch-up phenomenon occurs in the IC (white smoke) or damage.

The resonance phenomenon appears remarkably In the ESR value is small ceramic capacitors and the like of the capacitor. As a measure of this phenomenon, we can to reduce the resonance phenomenon to be short-circuited by connecting the short-circuit line and the series in more than 2Ω resistance. This allows you to prevent latch-up phenomenon in the IC.

In large tantalum and electrolytic capacitor of ESR, it generally influence of there resonance phenomenon ESR value is greater than or equal to 2Ω is reduced. Also, if a constraint or the like on your set can not be performed the measures as described above, please insert a schottky diode between GND terminal and the output terminal. This parasitic transistor in the internal IC will not work. A result, you can avoid the latch-up because the parasitic transistor does not work.

11.8 Thermal Resistance and Power Dissipation

•How to determine the thermal resistance when mounted on PCB

The thermal resistance when mounted is expressed as follows:

$$T_j = \theta_{JA} \times P_D + 25$$

T_j of IC is set around 150°C. P_D is the value when the thermal sensor is activated. If the ambient temperature is 25°C, then:

$$150 = \theta_{JA} \times P_D + 25$$

$$\theta_{JA} \times P_D + 25 = 150$$

$$\theta_{JA} \times P_D = 125$$

$$\theta_{JA} = \frac{125}{P_D} (\text{°C/W})$$

•Simple method to calculate Power Dissipation(P_D)

Mount the IC on the print circuit board. P_D will be V_{IN} × I_{IN} when the short circuit on the output side of the IC. The output terminal short-circuited with GND to measure gradually the input current gradually increase the input voltage. Increase gradually to 10V position the input voltage. Initial input current value is the maximum instantaneous output current value, but gradually decreased due to the temperature rise of the chip, it will eventually become a thermal equilibrium state (natural air cooling). This is calculated by using the input current value and the input voltage value when became constant.

$$P_D (\text{mW}) \cong V_{in}(\text{V}) \times I_{in}(\text{mA})$$

•Maximum available current at the maximum temperature

Available at the time the highest operating temperature current, you can ask in the graph of [Figure 5](#). Than DPD value obtained from the graph of [Figure 5](#), the maximum available current at the time of the maximum temperature can be calculated by the following equation.

$$I_{out} \cong \left\{ DP_D \div (V_{in,MAX} - V_{out}) \right\}$$

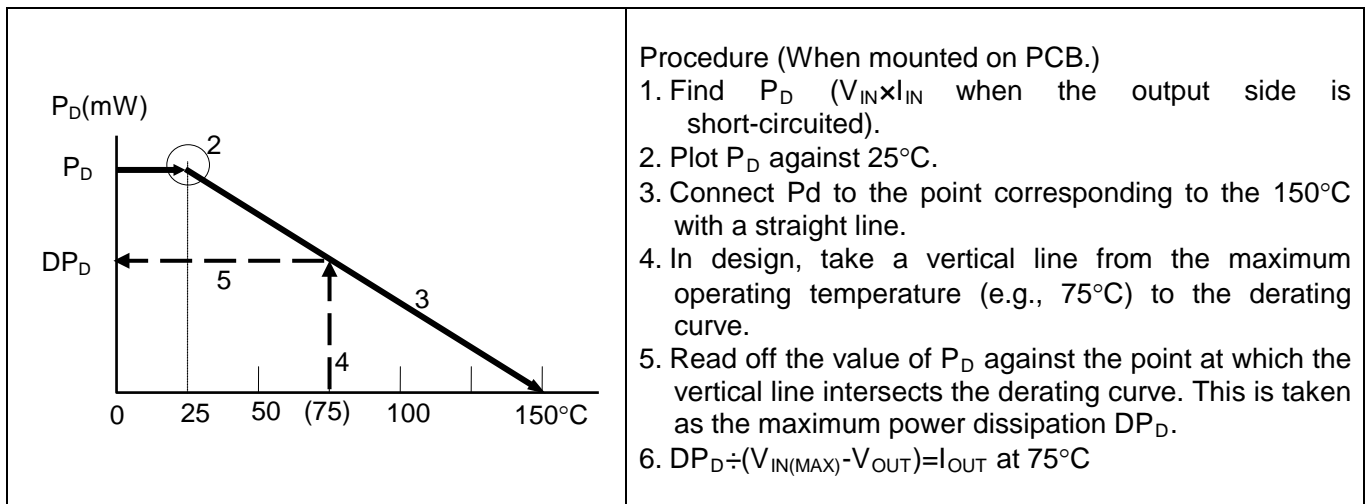

Figure 5. The simple method to calculate PD

12. Definition of term

■ Characteristics

Each characteristic will be measured in a short period not to be influenced by joint temperature (T_j).

- **Output Voltage (V_{OUT})**

The output voltage is specified with $V_{IN}=(V_{OUT(TYP)}+1V)$ and $I_{OUT}=5mA$.

- **Output Current (I_{OUT})**

Normal output current that can be used. And a range of overheat protection does not operation.

- **Maximum Output Current ($I_{OUT(MAX)}$)**

The rated output current is specified under the condition where the output voltage drops 0.3V the value specified with $I_{OUT}=5mA$. The input voltage is set to $V_{OUT(TYP)}+1V$ and the current is pulsed to minimize temperature effect.

- **Dropout Voltage (V_{DROP})**

The dropout voltage is the difference between the input voltage and the output voltage at which point the regulator starts to fall out of regulation. Below this value, the output voltage will fall as the input voltage is reduced. It is dependent upon the load current and the junction temperature.

- **Line Regulation ($LinReg$)**

Line regulation is the ability of the regulator to maintain a constant output voltage as the input voltage changes. The line regulation is specified as the input voltage is changed from $V_{IN}=V_{OUT(TYP)}+1V$ to $V_{OUT(TYP)}+6V$. It is a pulse measurement to minimize temperature effect.

- **Load Regulation ($LoaReg$)**

Load regulation is the ability of the regulator to maintain a constant output voltage as the load current changes. It is a pulsed measurement to minimize temperature effects with the input voltage set to $V_{IN}=V_{OUT(TYP)}+1V$. The load regulation is specified output current step conditions of 5mA to 100mA.

- **Ripple Rejection (R.R)**

Ripple rejection is the ability of the regulator to attenuate the ripple content of the input voltage at the output. It is specified with 200mVrms, 1kHz super-imposed on the input voltage, where $V_{IN}=V_{OUT}+1.5V$. Ripple rejection is the ratio of the ripple content of the output vs. input and is expressed in dB.

- **Standby Current ($I_{STANDBY}$)**

Standby current is the current, which flows into the regulator when the output is turned off by the control function ($V_{CONT}=0V$).

■ Protections

- **Over Current Protection**

The over current sensor protects the device when there is excessive output current. It also protects the device if the output is accidentally connected to ground.

- **Thermal Shutdown Protection**

When the power loss of the regulator there are many, it is the ability to limit such that does not exceed the allowable power consumption. Output and the chip temperature reaches about 150°C is turned OFF. However, when the temperature of the chip is reduced, and the output is turned ON again.

13. Recommended External Circuit

■ Recommended External Circuit

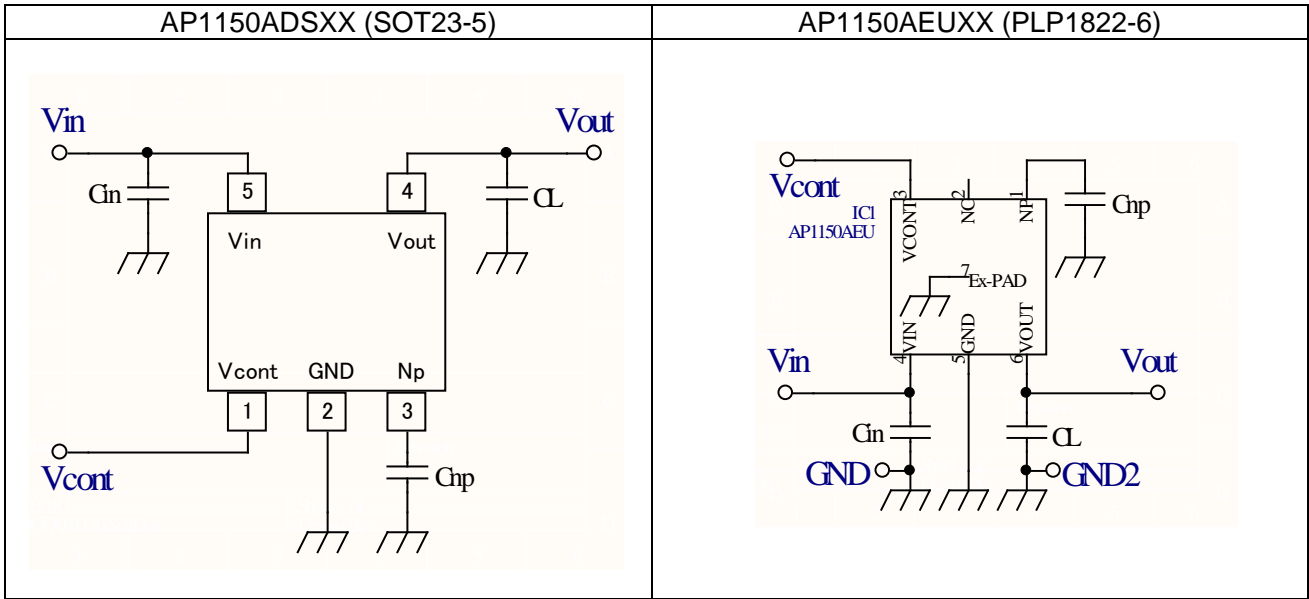

Figure 6. External connection circuit example

Table 5. Recommended external components example

Parts	min	typ	max	Unit	備考
C_{IN}	-	1.0	-	μF	
C_L	-	1.0	-	μF	
C_{NP}	-	0.001	-	μF	

Note 7. The above table of values is the recommended example. Please apply the optimal value on the check prior to the time of your on your board.

■ Recommended Layout

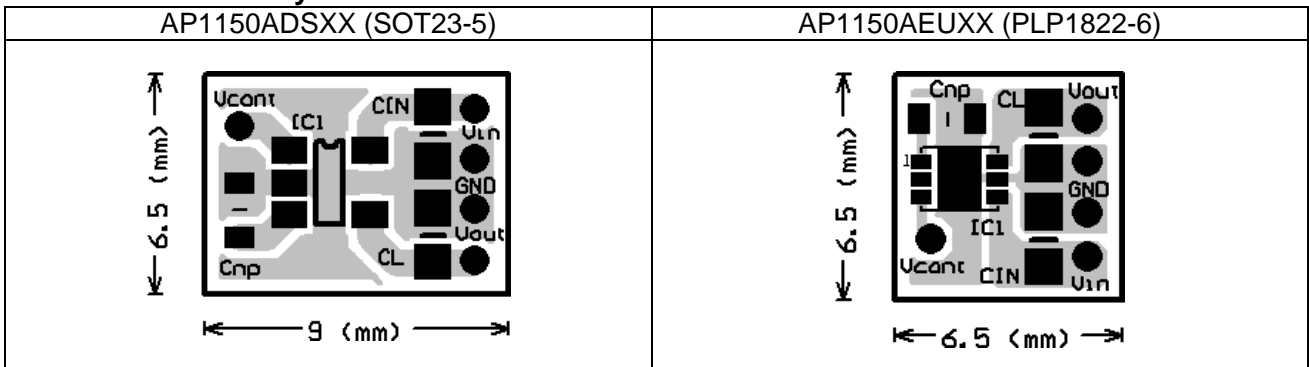

Figure 7. Layout pattern example

- ① Place the input capacitor C_{IN} as close as possible to the V_{IN} and GND.
- ② Place the output capacitor C_L as close as possible to the V_{OUT} and GND.
- ③ PCB wiring, so as to strengthen the GND area.
- ④ PLP1822-6 of Exposed-Pad has become a shared with the ground of the IC. Please connect to the PCB ground always. Vias (heat dissipation hole) is an effective heat dissipation to the PCB of each layer.

14. Package

■ Outline Dimensions

• SOT23-5

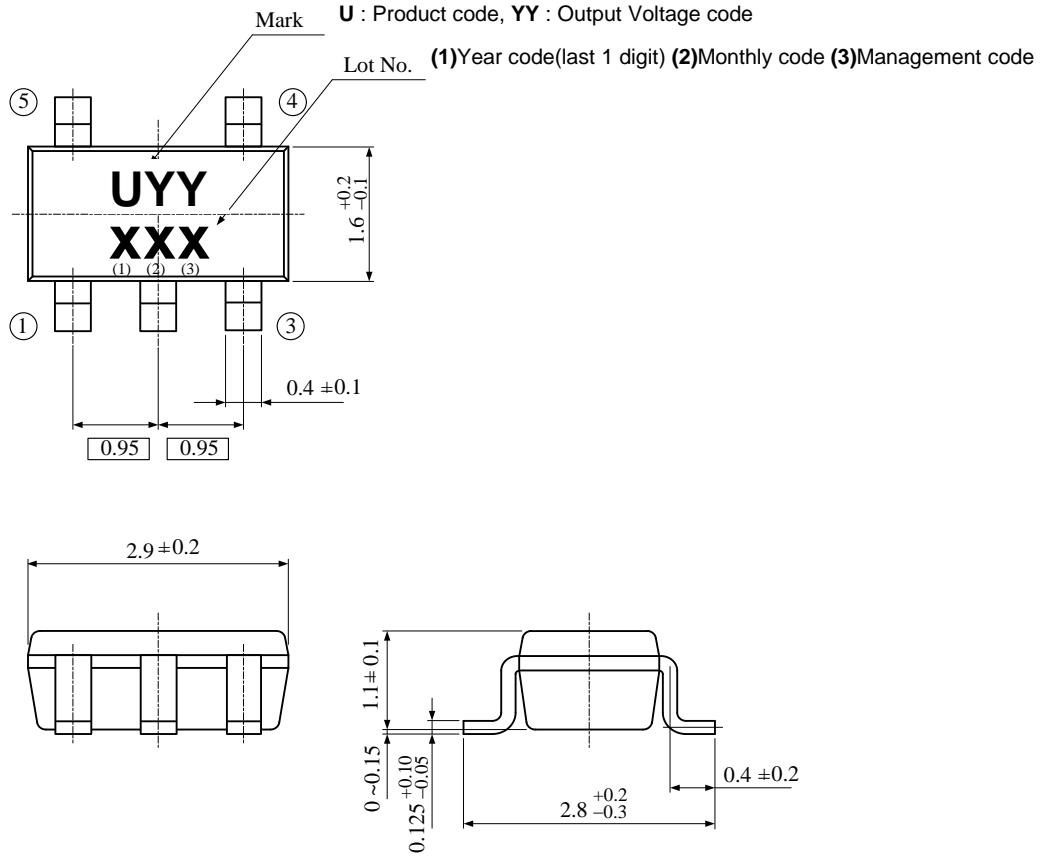

Unit : mm

• PLP1822-6

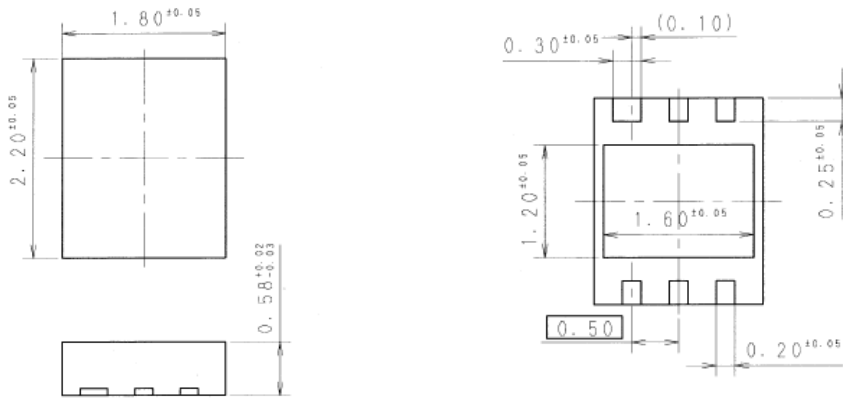

Unit : mm

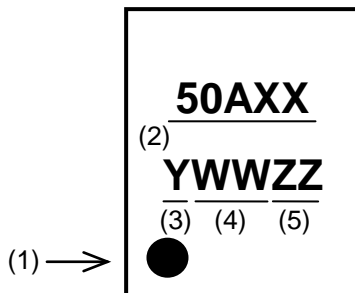

- (1) 1pin Indication
- (2) Market No. (XX:Output Voltage code)
- (3) Year code (last 1 digit)
- (4) Week code
- (5) Management code

15. Revise History

Date (YY/MM/DD)	Revision	Page	Contents
14/10/29	00	-	First edition
17/3/24	01	-	Completely revised as PLP1822-6 package is added

IMPORTANT NOTICE

0. Asahi Kasei Microdevices Corporation (“AKM”) reserves the right to make changes to the information contained in this document without notice. When you consider any use or application of AKM product stipulated in this document (“Product”), please make inquiries the sales office of AKM or authorized distributors as to current status of the Products.
1. All information included in this document are provided only to illustrate the operation and application examples of AKM Products. AKM neither makes warranties or representations with respect to the accuracy or completeness of the information contained in this document nor grants any license to any intellectual property rights or any other rights of AKM or any third party with respect to the information in this document. You are fully responsible for use of such information contained in this document in your product design or applications. AKM ASSUMES NO LIABILITY FOR ANY LOSSES INCURRED BY YOU OR THIRD PARTIES ARISING FROM THE USE OF SUCH INFORMATION IN YOUR PRODUCT DESIGN OR APPLICATIONS.
2. The Product is neither intended nor warranted for use in equipment or systems that require extraordinarily high levels of quality and/or reliability and/or a malfunction or failure of which may cause loss of human life, bodily injury, serious property damage or serious public impact, including but not limited to, equipment used in nuclear facilities, equipment used in the aerospace industry, medical equipment, equipment used for automobiles, trains, ships and other transportation, traffic signaling equipment, equipment used to control combustions or explosions, safety devices, elevators and escalators, devices related to electric power, and equipment used in finance-related fields. Do not use Product for the above use unless specifically agreed by AKM in writing.
3. Though AKM works continually to improve the Product’s quality and reliability, you are responsible for complying with safety standards and for providing adequate designs and safeguards for your hardware, software and systems which minimize risk and avoid situations in which a malfunction or failure of the Product could cause loss of human life, bodily injury or damage to property, including data loss or corruption.
4. Do not use or otherwise make available the Product or related technology or any information contained in this document for any military purposes, including without limitation, for the design, development, use, stockpiling or manufacturing of nuclear, chemical, or biological weapons or missile technology products (mass destruction weapons). When exporting the Products or related technology or any information contained in this document, you should comply with the applicable export control laws and regulations and follow the procedures required by such laws and regulations. The Products and related technology may not be used for or incorporated into any products or systems whose manufacture, use, or sale is prohibited under any applicable domestic or foreign laws or regulations.
5. Please contact AKM sales representative for details as to environmental matters such as the RoHS compatibility of the Product. Please use the Product in compliance with all applicable laws and regulations that regulate the inclusion or use of controlled substances, including without limitation, the EU RoHS Directive. AKM assumes no liability for damages or losses occurring as a result of noncompliance with applicable laws and regulations.
6. Resale of the Product with provisions different from the statement and/or technical features set forth in this document shall immediately void any warranty granted by AKM for the Product and shall not create or extend in any manner whatsoever, any liability of AKM.
7. This document may not be reproduced or duplicated, in any form, in whole or in part, without prior written consent of AKM.