



AP1153ADSXX

14V Input / 100mA Output LDO Regulator

1. General Description

The AP1153ADSXX is a low dropout linear regulator with ON/OFF control, which can supply 100mA load current. The IC is an integrated circuit with a silicon monolithic bipolar structure. The output voltage, trimmed with high accuracy, is available from 1.3 to 5.0V in 0.1V steps. The output capacitor is available to use a small 0.22 μ F ceramic capacitor. The over current, thermal and reverse bias protections are integrated, and also the package is small and thin type. The IC is designed for space saving requirements.

2. Feature

- Available to use a small 0.22 μ F ceramic capacitor
- Dropout Voltage $V_{\text{DROP}}=160\text{mV}$ at 100mA
- Output Current 100mA
- High Precision output voltage $\pm 1.5\%$ or $\pm 50\text{mV}$
- High ripple rejection ratio 80dB at 1kHz
70dB at 10kHz
- Wide operating voltage range 2.1V to 14.0V
- Very low quiescent current $I_{\text{QUT}}=75\mu\text{A}$ at $I_{\text{OUT}}=0\text{mA}$
- On/Off control (High active)
- Built-in Short circuit protection, thermal shutdown
- Built-in reverse bias over current protection
- Available very low noise application
- Very small surface mount package SOT23-5

3. Application

- Automotive accessory equipment
- Any Electronic Equipment
- Battery Powered Systems
- Mobile Communication

4. Table of Contents

1. General Description	1
2. Feature.....	1
3. Application.....	1
4. Table of Contents.....	2
5. Block Diagram.....	3
6. Ordering Information	4
7. Pin Configurations and Functions.....	5
■ Pin Configurations.....	5
■ Functions	5
8. Absolute Maximum Ratings	6
9. Recommended Operating Conditions	6
10. Electrical Characteristics.....	7
■ Electrical Characteristics of Ta=Tj=25°C	7
■ Electrical Characteristics of Ta=-40°C~85°C	9
11. Description.....	11
11.1 DC Characteristics.....	11
11.2 Temperature Characteristics	14
11.3 Ripple Rejection	16
11.4 ON/OFF transient	17
11.5 ON/OFF transient	18
11.6 Line transient.....	19
11.7 Output noise	20
11.8 Stability.....	21
11.9 Operating Region and Power Dissipation	23
11.10 ON/OFF Control.....	24
11.11 Noise Bypass	25
11.12 The notes of the evaluation when output terminal is short-circuit to GND.....	25
12. Definition of term.....	26
13. Recommended External Circuits	27
■ External Circuit	27
■ Test Circuit	27
14. Package.....	28
■ Outline Dimensions	28
15. Revise History.....	29
IMPORTANT NOTICE.....	30

5. Block Diagram

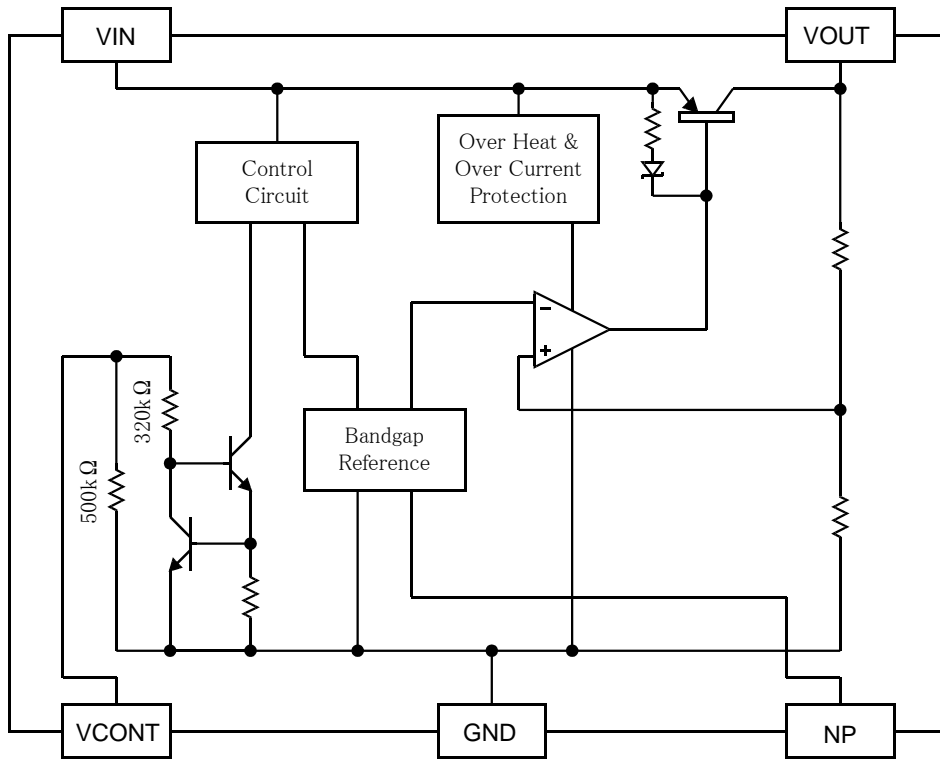

Figure 1. Block Diagram

6. Ordering Information

AP1153ADSXX Ta = -40 to 85°C SOT23-5

• Output Voltage Code

For product name, please check the below chart. Please contact your authorized ASAHI KASEI MICRODEVICES representative for voltage availability.

AP1153ADSXX
└─── Output voltage code

Table 1. Standard Voltage Version, Output Voltage & Voltage Code

XX	VOUT	XX	VOUT	XX	VOUT
18	1.8	28	2.8	33	3.3
21	2.1	30	3.0	50	5.0

Table 2. Optional Voltage Version, Output Voltage & Voltage Code

XX	VOUT	XX	VOUT	XX	VOUT	XX	VOUT
13	1.3	24	2.4	36	3.6	45	4.5
14	1.4	25	2.5	37	3.7	46	4.6
15	1.5	26	2.6	38	3.8	47	4.7
16	1.6	27	2.7	39	3.9	48	4.8
17	1.7	29	2.9	40	4.0	49	4.9
19	1.9	31	3.1	41	4.1	-	-
20	2.0	32	3.2	42	4.2	-	-
22	2.2	34	3.4	43	4.3	-	-
23	2.3	35	3.5	44	4.4	-	-

7. Pin Configurations and Functions

■ Pin Configurations

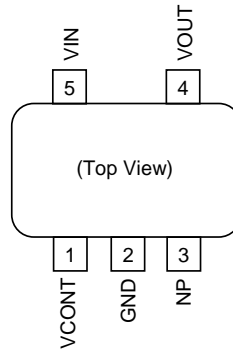

■ Functions

Pin No.	Pin Description	Internal Equivalent Circuit	Description
1	VCONT		<p>On/Off Control Terminal</p> <p>$V_{cont} > 1.8V$: ON $V_{cont} < 0.35V$: OFF</p> <p>The pull-down resistor (500kΩ) is built-in.</p>
2	GND	-	GND Terminal
3	NP		<p>Noise Bypass Terminal</p> <p>Connect a bypass capacitor between GND.</p>
4	VOUT		Output Terminal
5	VIN	-	Input Terminal

8. Absolute Maximum Ratings

Parameter	Symbol	min	max	Unit	Condition
Supply Voltage	$V_{CC_{MAX}}$	-0.4	16	V	
Reverse Bias	$V_{rev_{MAX}}$	-0.4	6	V	$V_{out} \leq 2.0V$
		-0.4	12	V	$2.1V \leq V_{out}$
Np pin Voltage	$V_{np_{MAX}}$	-0.4	5	V	
Control pin Voltage	$V_{cont_{MAX}}$	-0.4	16	V	
Junction temperature	T_j	-	150	°C	
Storage Temperature Range	T_{stg}	-55	150	°C	
Power Dissipation	P_D	-	500	mW	When mounted on PCB (Note 1)

Note 1. Please do derating with 4.0mW/°C at $P_D=500mW$ and 25°C or more. Thermal resistance $\theta_{JA} = 250^\circ C/W$.

WARNING: The maximum ratings are the absolute limitation values with the possibility of the IC breakage. When the operation exceeds this standard quality cannot be guaranteed.

9. Recommended Operating Conditions

Parameter	Symbol	min	typ	max	Unit	Condition
Operating Temperature Range	T_a	-40	-	85	°C	
Operating Voltage Range	V_{OP}	2.1	-	14	V	

10. Electrical Characteristics

■ Electrical Characteristics of Ta=Tj=25°C

The parameters with min or max values will be guaranteed at Ta=Tj=25°C.

(V_{IN}=V_{outtyp}+1V, V_{cont}=1.8V, Ta=Tj=25°C, unless otherwise specified.)

Parameter	Symbol	Condition	min	typ	max	Unit
Output Voltage	V _{out}	I _{out} = 5mA	(Table 3, Table 4)			V
Line Regulation	LinReg	ΔV _{in} = 5V	-	0.0	5.0	mV
Load Regulation	LoaReg	I _{out} = 5mA ~ 50mA	(Table 3, Table 4)			mV
		I _{out} = 5mA ~ 100mA				mV
Dropout Voltage (Note 2)	V _{drop}	I _{out} = 50mA	-	90	160	mV
		I _{out} = 100mA	-	160	280	mV
Output Current (Note 3)	I _{out}		-	-	100	mA
Maximum Output Current (Note 3)	I _{outMAX}	V _{out} =V _{out_TYP} ×0.9	150	200	-	mA
Supply Current	I _{cc}	I _{out} = 0mA	-	75	120	μA
Standby Current	I _{standby}	V _{cont} = 0V	-	0.0	0.1	μA
Quiescent Current	I _q	I _{out} = 50mA	-	1.5	2.7	mA
Control Terminal						
Control Current	I _{cont}	V _{cont} = 1.8V	-	5.0	15.0	μA
Control Voltage	V _{cont}	V _{out} ON state	1.8	-	-	V
		V _{out} OFF state	-	-	0.35	V
Reference Value						
Np Terminal Voltage	V _{np}		-	1.26	-	V
Output Voltage / Temp.	V _{out} /Ta		-	35	-	ppm /°C
Short Circuit Current	I _{SHORT}		-	200	-	mA
Output Noise Voltage (V _{out_TYP} =3.0V)	V _{noise}	C _{out} =1.0μF, C _{np} =0.01μF I _{out} =30mA	-	38	-	μV rms
Ripple Rejection (V _{out_TYP} =3.0V)	RR	C _{out} =1.0μF, C _{np} =0.001μF I _{out} =10mA, f=1kHz	-	80	-	dB
		f=10kHz	-	70	-	dB
Rise Time (V _{out_TYP} =3.0V)	t _r	C _{out} =1.0μF, C _{np} =0.001μF V _{cont} : Pulse Wave (100Hz) V _{cont} ON → V _{out} ×95% point	-	35	-	μs

Note 2. For V_{out} ≤ 2.0V, no regulations.

Note 3. The maximum output current is limited by power dissipation.

General Note:

Parameter with only typical value is for reference only.

Table 3. Standard Voltage Version

Part Number	Output Voltage			Load Regulation			
				Iout = 50mA		Iout = 100mA	
	min	typ	max	typ	max	typ	max
	V	V	V	V	V	mV	mV
AP1153ADS18	1.750	1.800	1.850	5	12	11	26
AP1153ADS21	2.050	2.100	2.150	5	12	12	28
AP1153ADS28	2.750	2.800	2.850	6	14	14	34
AP1153ADS30	2.950	3.000	3.050	6	15	15	35
AP1153ADS33	3.250	3.300	3.350	7	16	16	37
AP1153ADS50	4.925	5.000	5.075	9	20	21	50

Table 4. Optional Voltage Version

Part Number	Output Voltage			Load Regulation			
				Iout = 50mA		Iout = 100mA	
	min	typ	max	typ	max	typ	max
	V	V	V	V	V	mV	mV
AP1153ADS13	1.250	1.300	1.350	5	10	10	22
AP1153ADS14	1.350	1.400	1.450	5	10	10	23
AP1153ADS15	1.450	1.500	1.550	5	11	10	24
AP1153ADS16	1.550	1.600	1.650	5	11	11	25
AP1153ADS17	1.650	1.700	1.750	5	11	11	25
AP1153ADS19	1.850	1.900	1.950	5	12	11	27
AP1153ADS20	1.950	2.000	2.050	5	12	12	28
AP1153ADS22	2.150	2.200	2.250	6	13	12	29
AP1153ADS23	2.250	2.300	2.350	6	13	13	30
AP1153ADS24	2.350	2.400	2.450	6	13	13	31
AP1153ADS25	2.450	2.500	2.550	6	14	13	31
AP1153ADS26	2.550	2.600	2.650	6	14	14	32
AP1153ADS27	2.650	2.700	2.750	6	14	14	33
AP1153ADS29	2.850	2.900	2.950	6	15	15	34
AP1153ADS31	3.050	3.100	3.150	7	15	15	36
AP1153ADS32	3.150	3.200	3.250	7	15	16	37
AP1153ADS34	3.349	3.400	3.451	7	16	16	38
AP1153ADS35	3.447	3.500	3.553	7	16	16	39
AP1153ADS36	3.546	3.600	3.654	7	17	17	40
AP1153ADS37	3.644	3.700	3.756	7	17	17	40
AP1153ADS38	3.743	3.800	3.857	7	17	17	41
AP1153ADS39	3.841	3.900	3.959	8	17	18	42
AP1153ADS40	3.940	4.000	4.060	8	18	18	43
AP1153ADS41	4.038	4.100	4.162	8	18	18	43
AP1153ADS42	4.137	4.200	4.263	8	18	19	44
AP1153ADS43	4.235	4.300	4.365	8	18	19	45
AP1153ADS44	4.334	4.400	4.466	8	19	19	46
AP1153ADS45	4.432	4.500	4.568	8	19	20	46
AP1153ADS46	4.531	4.600	4.669	8	19	20	47
AP1153ADS47	4.629	4.700	4.771	8	20	20	48
AP1153ADS48	4.728	4.800	4.872	9	20	21	49
AP1153ADS49	4.826	4.900	4.974	9	20	21	49

■ Electrical Characteristics of Ta=-40°C~85°C

The parameters with min or max values will be guaranteed at Ta=Tj=-40 ~ 85°C.

(V_{IN}=V_{out_TYP}+1V, V_{cont}=1.8V, Ta=-40 ~ 85°C, unless otherwise specified.)

Parameter	Symbol	Condition	min	typ	max	Unit
Output Voltage	V _{out}	I _{out} = 5mA	(Table 5, Table 6)			V
Line Regulation	LinReg	ΔV _{in} = 5V		0.0	8.0	mV
Load Regulation	LoaReg	I _{out} = 5mA ~ 50mA	(Table 5, Table 6)			mV
		I _{out} = 5mA ~ 100mA				mV
Dropout Voltage (Note 4)	V _{drop}	I _{out} = 50mA		90	205	mV
		I _{out} = 100mA		160	360	mV
Output Current (Note 5)	I _{out}				100	mA
Maximum Output Current (Note 5)	I _{out_MAX}	V _{out} =V _{out_TYP} ×0.9	110	200	-	mA
Supply Current	I _{cc}	I _{out} = 0mA		75	145	μA
Standby Current	I _{standby}	V _{cont} = 0V		0.0	0.5	μA
Quiescent Current	I _q	I _{out} = 50mA		1.5	3.3	mA
Control Terminal						
Control Current	I _{cont}	V _{cont} = 1.8V	-	5.0	15.0	μA
Control Voltage	V _{cont}	V _{out} ON state	1.8	-	-	V
		V _{out} OFF state	-	-	0.35	V
Reference Value						
Np Terminal Voltage	V _{np}			1.26		V
Output Voltage / Temp.	V _{out} /Ta			35		ppm / °C
Short Circuit Current	I _{SHORT}			200		mA
Output Noise Voltage (V _{out_TYP} =3.0V)	V _{noise}	C _{out} =1.0μF, C _{np} =0.01μF I _{out} =30mA		38		μV rms
Ripple Rejection (V _{out_TYP} =3.0V)	RR	C _{out} =1.0μF, C _{np} =0.001μF I _{out} =10mA, f=1kHz		80		dB
		f=10kHz		70		dB
Rise Time (V _{out_TYP} =3.0V)	tr	C _{out} =1.0μF, C _{np} =0.001μF V _{cont} : Pulse Wave (100Hz) V _{cont} ON → V _{out} ×95% point		35		μs

Note 4. For V_{out} ≤ 2.0V, no regulations.

Note 5. The maximum output current is limited by power dissipation.

General Note:

Parameter with only typical value is for reference only.

Table 5. Standard Voltage Version

Part Number	Output Voltage			Load Regulation			
				Iout = 50mA		Iout = 100mA	
	min	typ	max	typ	max	typ	max
	V	V	V	V	V	mV	mV
AP1153ADS18	1.720	1.800	1.880	5	14	11	29
AP1153ADS21	2.020	2.100	2.180	5	14	12	31
AP1153ADS28	2.720	2.800	2.880	6	16	14	37
AP1153ADS30	2.920	3.000	3.080	6	17	15	38
AP1153ADS33	3.217	3.300	3.383	7	18	16	40
AP1153ADS50	4.875	5.000	5.125	9	22	21	55

Table 6. Optional Voltage Version

Part Number	Output Voltage			Load Regulation			
				Iout = 50mA		Iout = 100mA	
	min	typ	max	typ	max	typ	max
	V	V	V	V	V	mV	mV
AP1153ADS13	1.220	1.300	1.380	5	12	10	25
AP1153ADS14	1.320	1.400	1.480	5	12	10	26
AP1153ADS15	1.420	1.500	1.580	5	13	10	27
AP1153ADS16	1.520	1.600	1.680	5	13	11	28
AP1153ADS17	1.620	1.700	1.780	5	13	11	28
AP1153ADS19	1.820	1.900	1.980	5	14	11	30
AP1153ADS20	1.920	2.000	2.080	5	14	12	31
AP1153ADS22	2.120	2.200	2.280	6	15	12	32
AP1153ADS23	2.220	2.300	2.380	6	15	13	33
AP1153ADS24	2.320	2.400	2.480	6	15	13	34
AP1153ADS25	2.420	2.500	2.580	6	16	13	34
AP1153ADS26	2.520	2.600	2.680	6	16	14	35
AP1153ADS27	2.620	2.700	2.780	6	16	14	36
AP1153ADS29	2.820	2.900	2.980	6	17	15	37
AP1153ADS31	3.020	3.100	3.180	7	17	15	39
AP1153ADS32	3.120	3.200	3.280	7	17	16	40
AP1153ADS34	3.312	3.400	3.488	7	18	16	41
AP1153ADS35	3.412	3.500	3.588	7	18	16	42
AP1153ADS36	3.510	3.600	3.690	7	19	17	43
AP1153ADS37	3.605	3.700	3.795	7	19	17	43
AP1153ADS38	3.705	3.800	3.895	7	19	17	44
AP1153ADS39	3.805	3.900	3.995	8	19	18	45
AP1153ADS40	3.900	4.000	4.100	8	20	18	46
AP1153ADS41	3.986	4.100	4.214	8	20	18	47
AP1153ADS42	4.085	4.200	4.315	8	20	19	48
AP1153ADS43	4.184	4.300	4.416	8	20	19	49
AP1153ADS44	4.283	4.400	4.517	8	21	19	50
AP1153ADS45	4.382	4.500	4.618	8	21	20	50
AP1153ADS46	4.481	4.600	4.719	8	21	20	51
AP1153ADS47	4.580	4.700	4.820	8	22	20	52
AP1153ADS48	4.679	4.800	4.921	9	22	21	54
AP1153ADS49	4.777	4.900	5.023	9	20	21	54

11. Description

11.1 DC Characteristics

■ Line Regulation

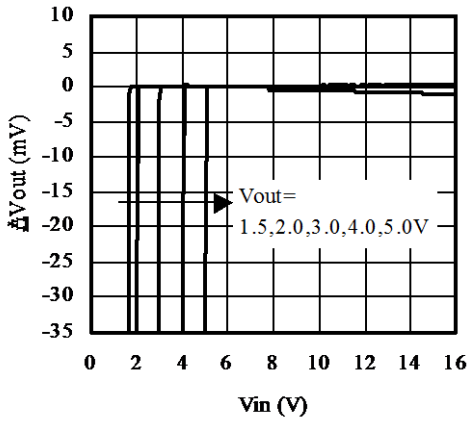

Test conditions

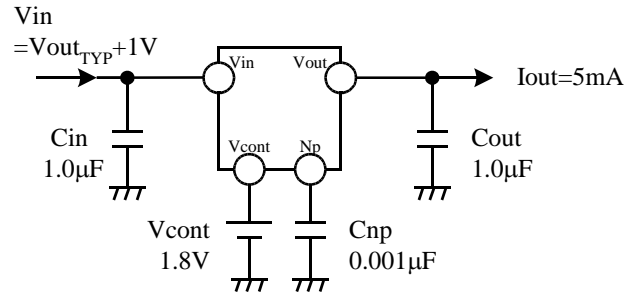

■ I_{in} vs V_{IN}
 $I_{out}=0mA$

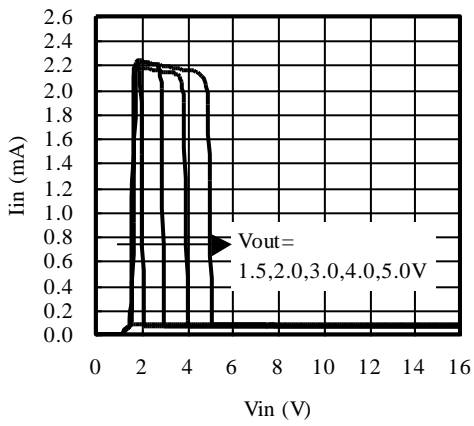

■ Quiescent Current
 $I_{out}=0mA$

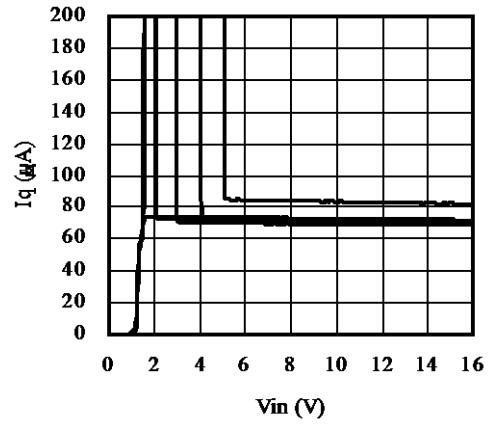

■ Load Regulation

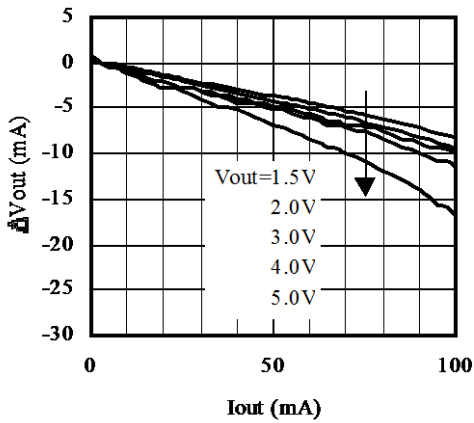

■ Peak Output Current

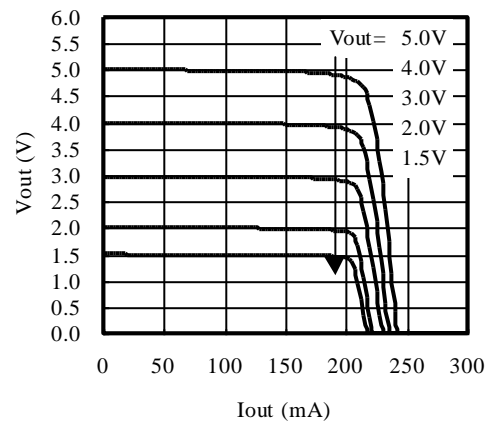

■ GND Pin Current

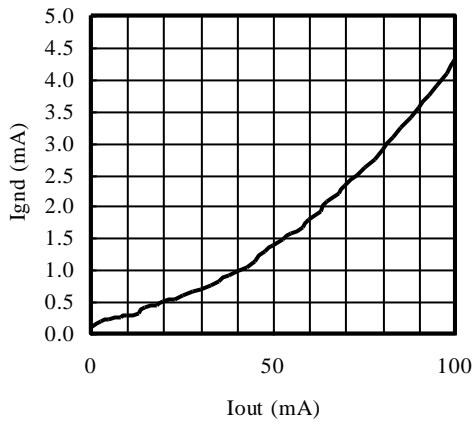

Test conditions

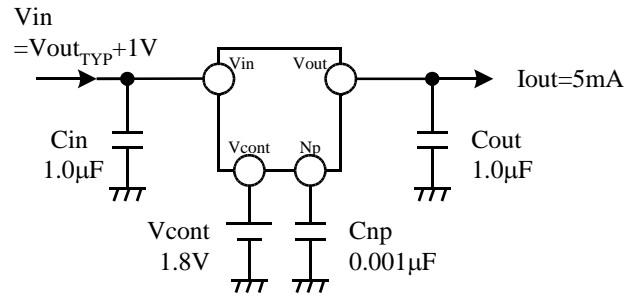

■ Dropout Voltage

$2.1V \leq V_{outtyp}$

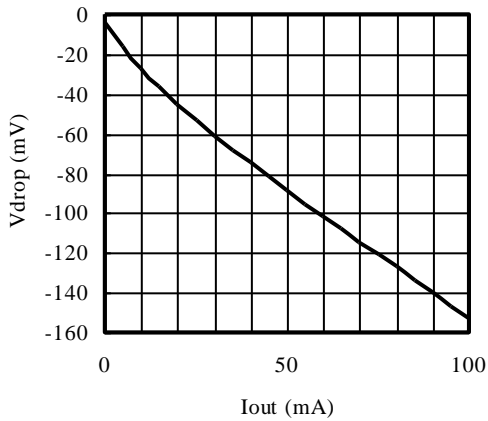

■ Standby Current (Off state)

$V_{cont} = 0V$

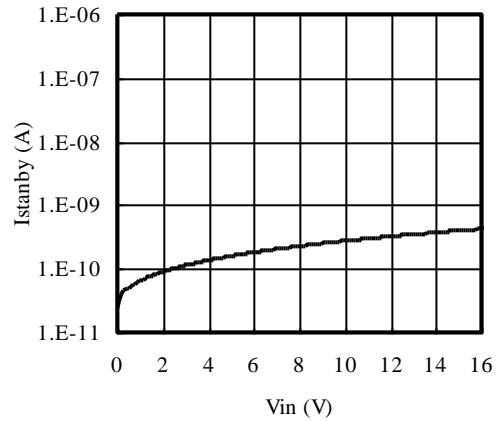

■ Control Current

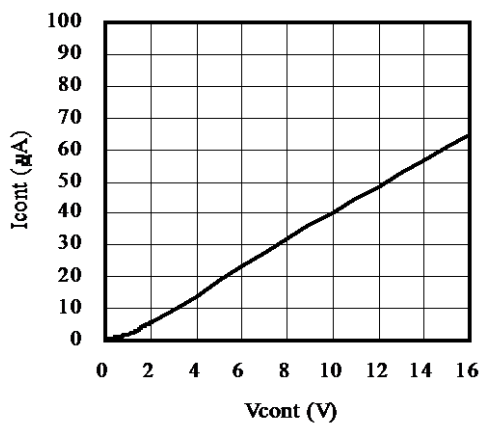

■ Control Current, ON/OFF Point

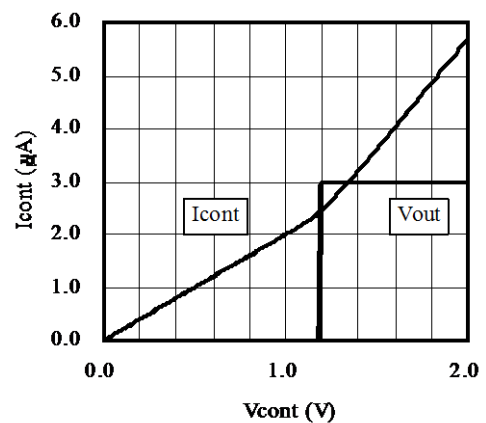

■ Vout vs VIN Regulation Point
 $2.1V \leq V_{outtyp}$

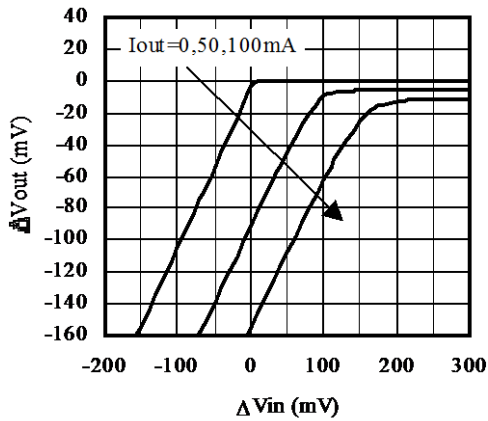

Test conditions

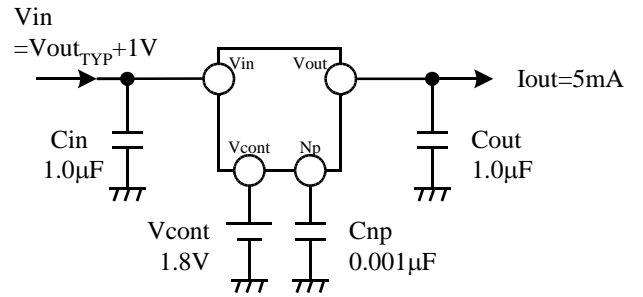

■ Vout vs VIN Regulation Point
 $V_{outtyp} = 1.5V$

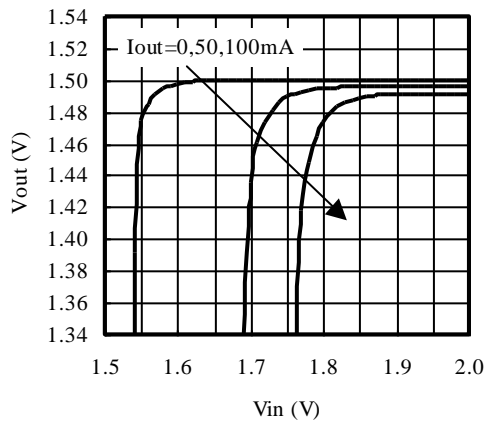

■ Vout vs VIN Regulation Point
 $V_{outtyp} = 2.0V$

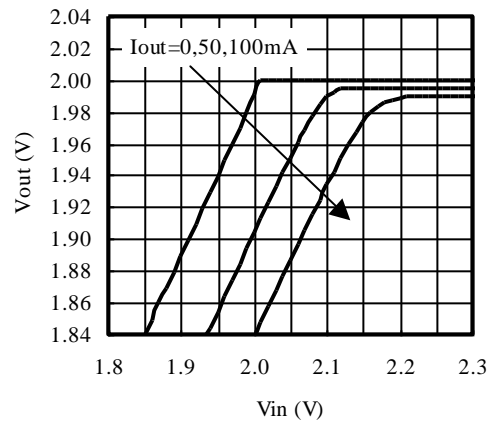

■ Reverse Bias Current
 $V_{IN} = 0V, V_{cont} = 0V$

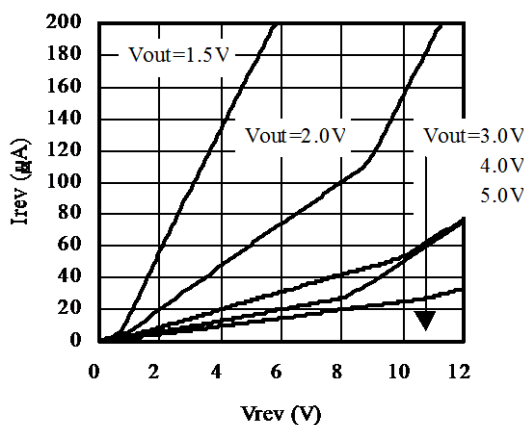

Test conditions

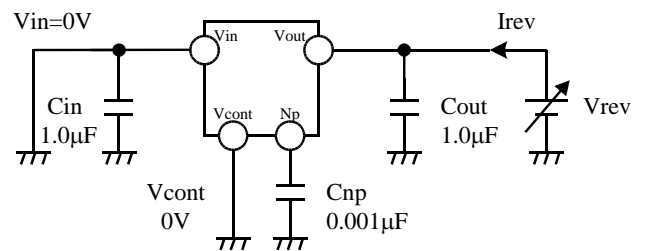

11.2 Temperature Characteristics

■ Vout

Vouttyp=3.0V

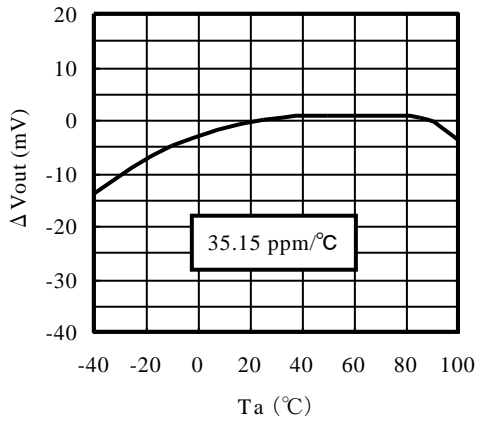

Test conditions

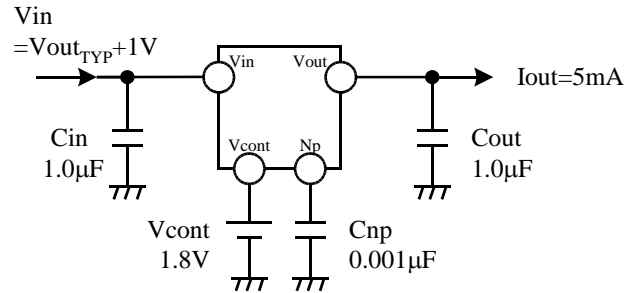

■ Peak Output Current

Vout=Vouttyp × 0.9

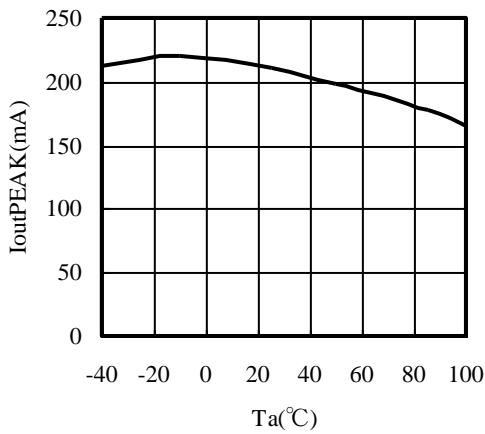

■ GND Pin Current

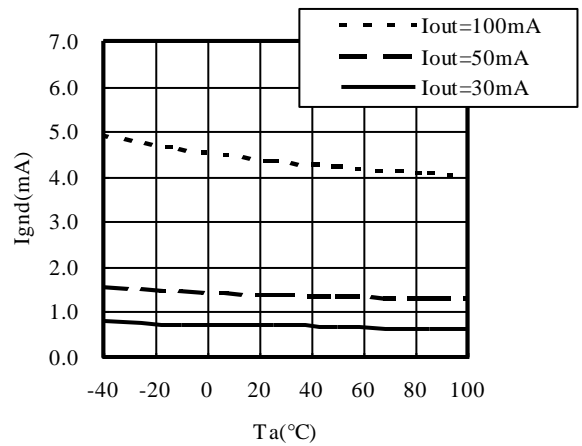

■ Dropout Voltage

2.1V ≤ Vouttyp

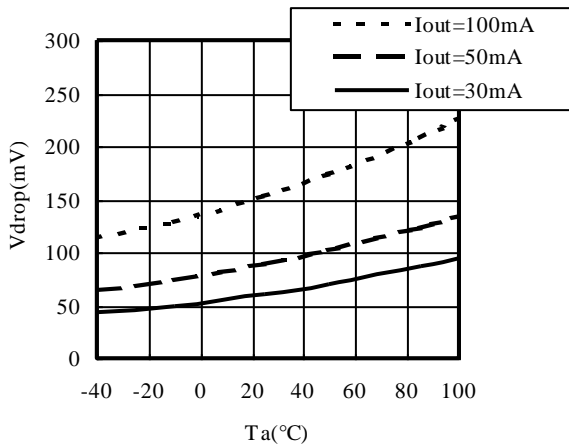

■ Quiescent Current

Iout=0mA

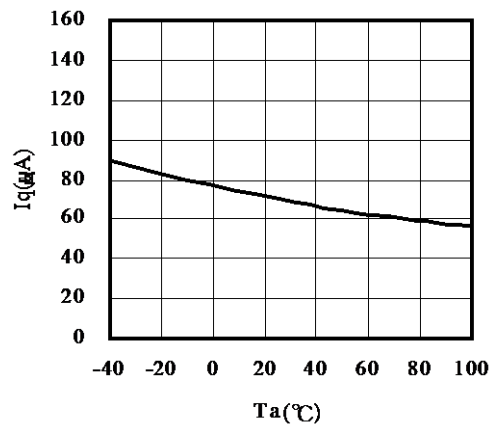

■ Load Regulation
 $V_{outtyp}=3.0V$

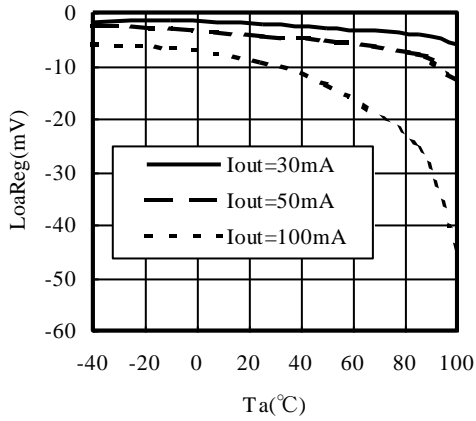

■ Line Regulation
 $\Delta V_{IN} = 5V$

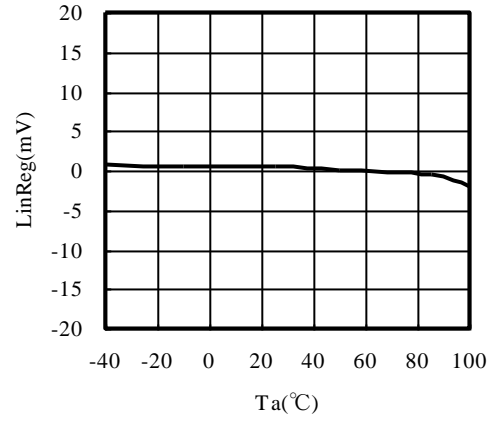

■ Control Current

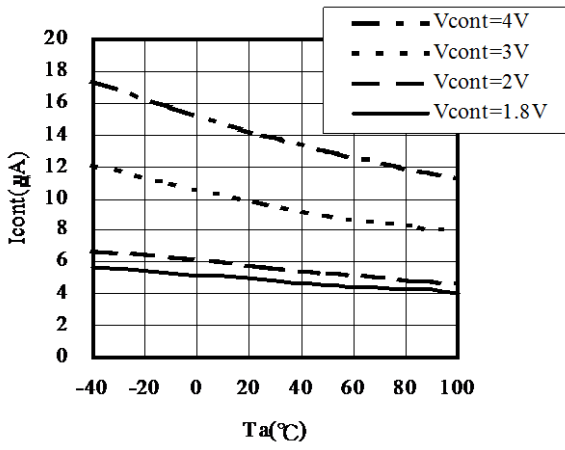

■ ON/OFF Point

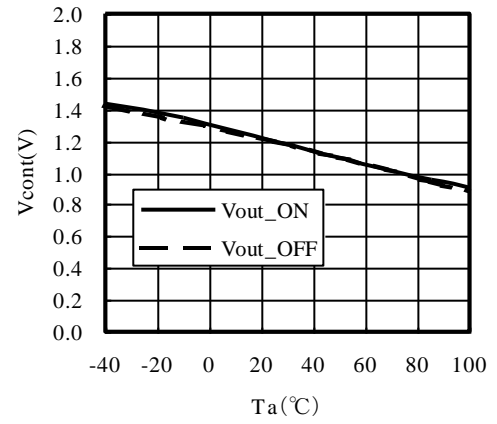

11.3 Ripple Rejection

■ $C_{out}=0.22\mu\text{F}, 0.47\mu\text{F}, 1.0\mu\text{F}, 2.2\mu\text{F}$

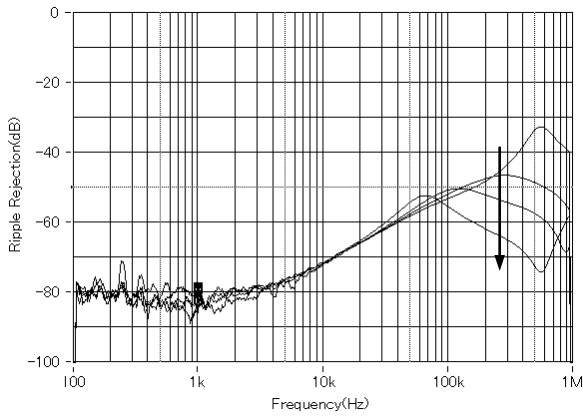

Test conditions

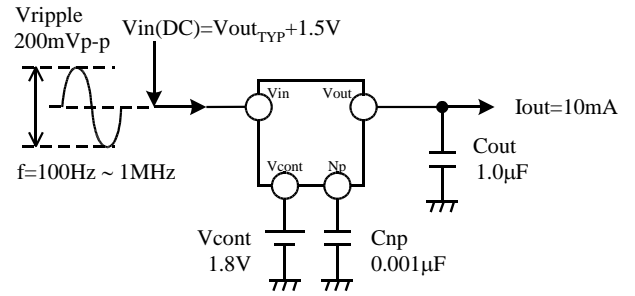

■ $C_{np}=0.001\mu\text{F}, 0.01\mu\text{F}, 0.1\mu\text{F}$

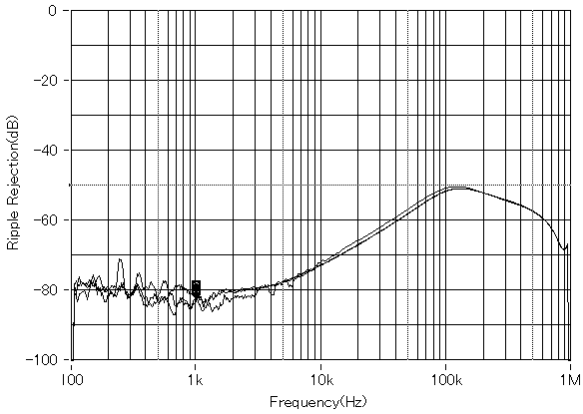

■ $I_{out}=10\text{mA}, 20\text{mA}, 50\text{mA}, 100\text{mA}$

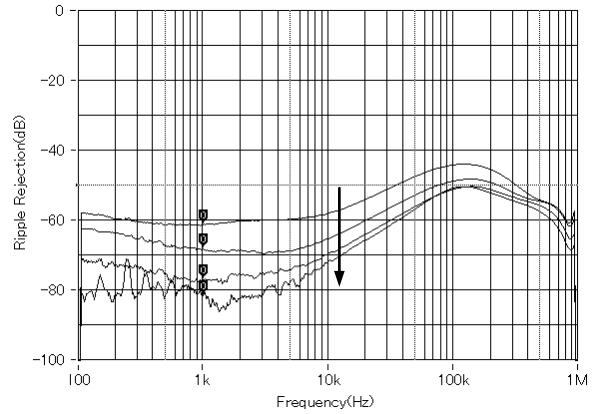

■ R.R vs I_{out} : Frequency=1kHz

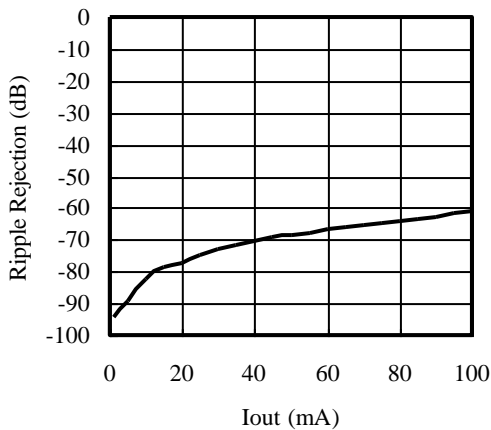

■ R.R vs Low V_{IN} : Frequency=1kHz

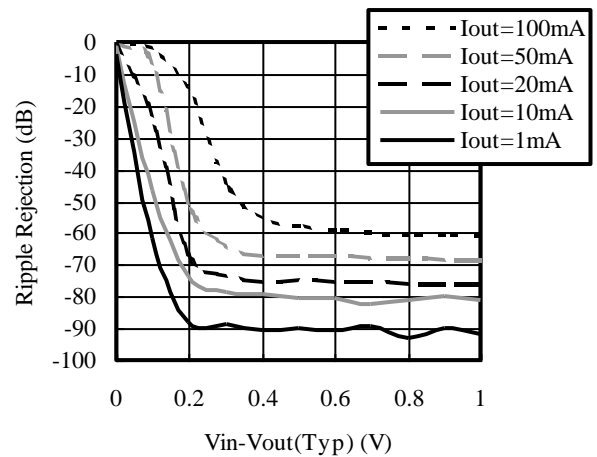

The ripple rejection (R.R) characteristic depends on the characteristic and the capacitance of the output capacitor. The R.R characteristic at 50kHz or more varies greatly with the capacitor on the output side and PCB pattern. Please check stability during operation.

11.4 ON/OFF transient

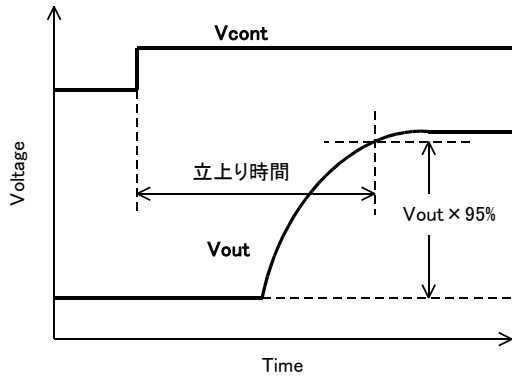

Test conditions

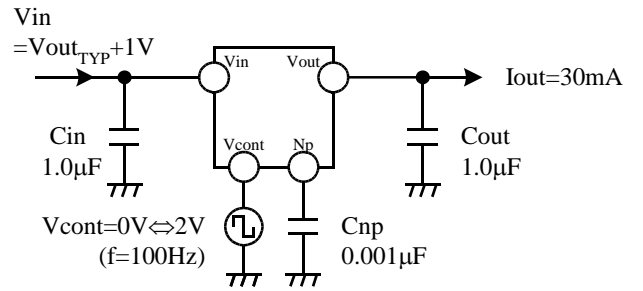

■ Cout=0.47µF, 1.0µF, 2.2µF

■ Cout=0.47µF, 1.0µF, 2.2µF

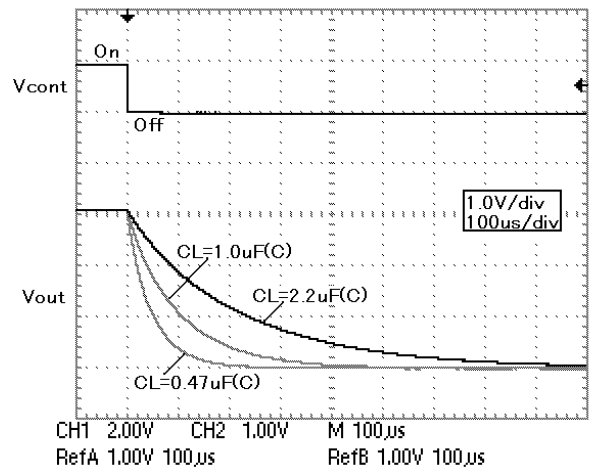
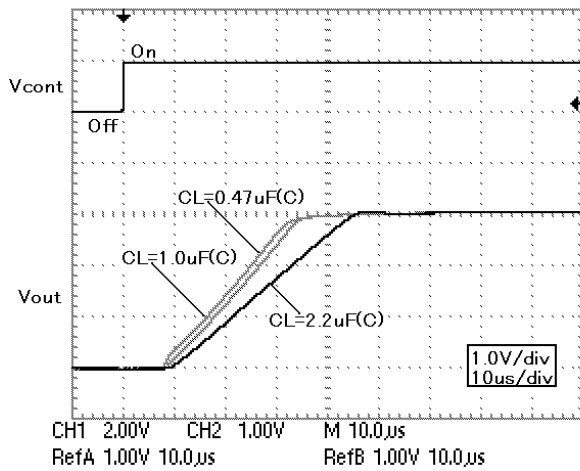

■ Cnp=0.001µF, 0.01µF, 0.1µF

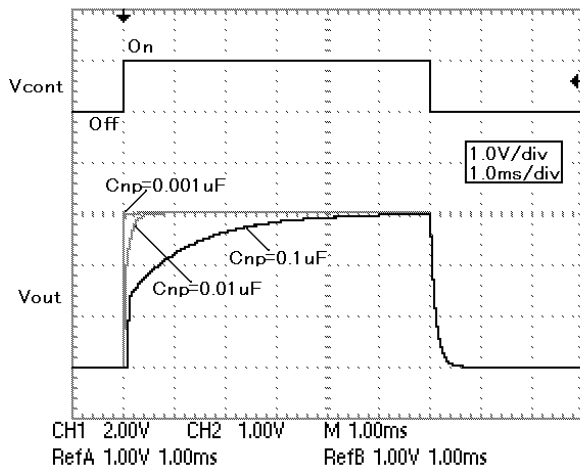

Rise time becomes longer if Cout or Cnp becomes larger.
Fall time depends on Cout.

11.5 ON/OFF transient

Test conditions

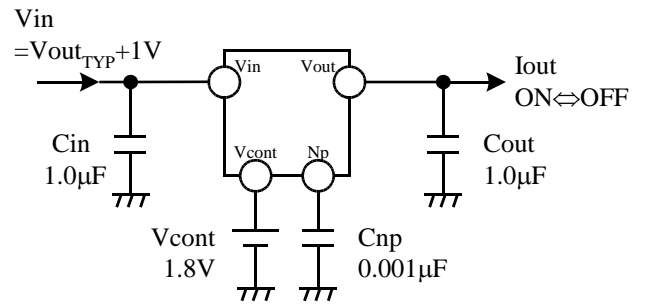

■ Iout=0⇒100mA, 5⇒105mA

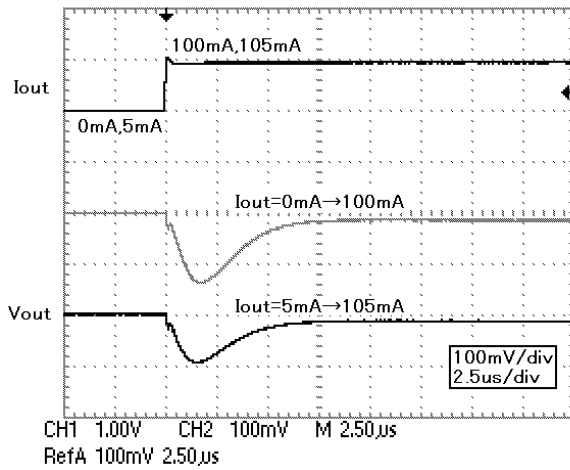

■ Iout=100mA⇒0mA, 105mA⇒5mA

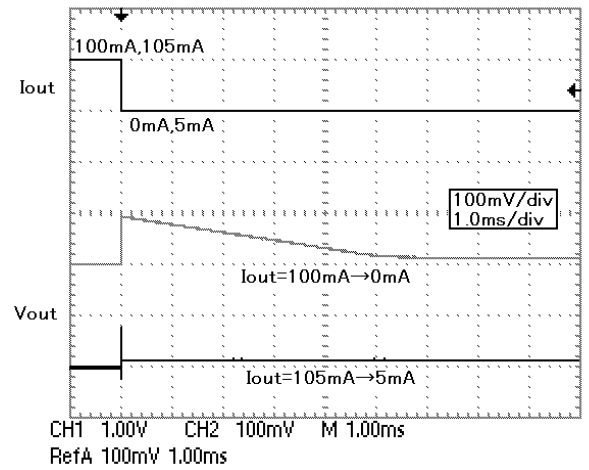

■ Cout=0.47µF, 1.0µF, 2.2µF : Iout=0mA⇒100mA

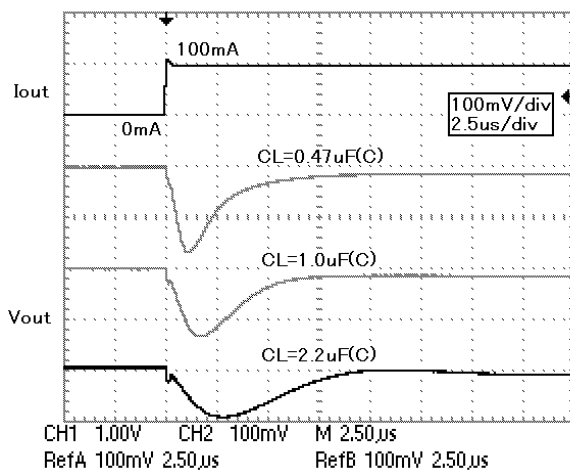

■ Cout=0.47µF, 1.0µF, 2.2µF : Iout=100mA⇒0mA

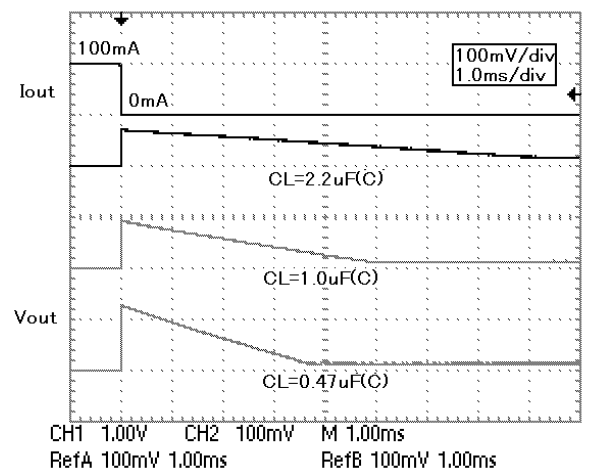

Increase the load side capacitor when the load change is fast or when there is a large current change. In addition, at no load, supplying small load current to ground can reduce the voltage change.

11.6 Line transient

■ Cnp=0.001μF, 0.01μF, 0.1μF

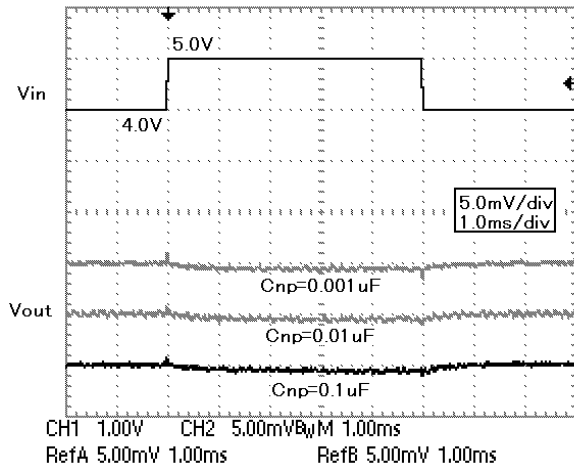

Test conditions

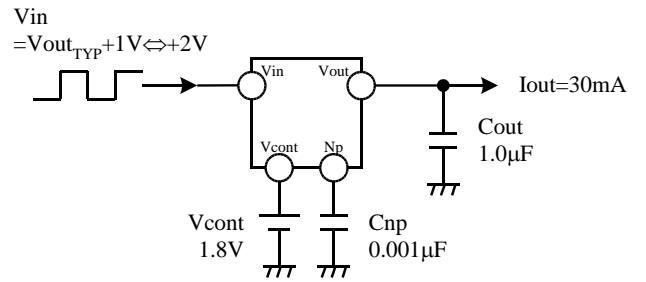

■ Cout=0.1μF, 0.22μF, 0.47μF

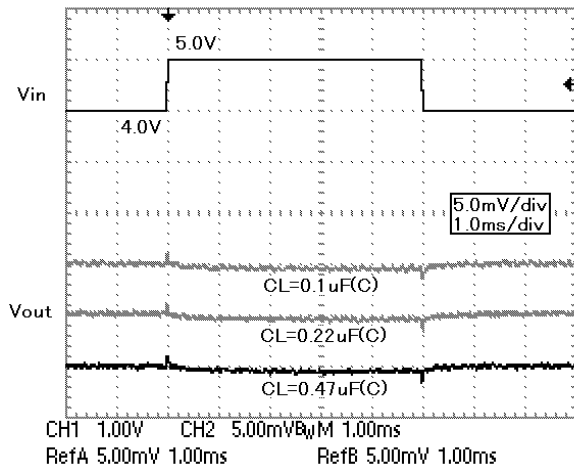

■ Cout=1.0μF, 2.2μF

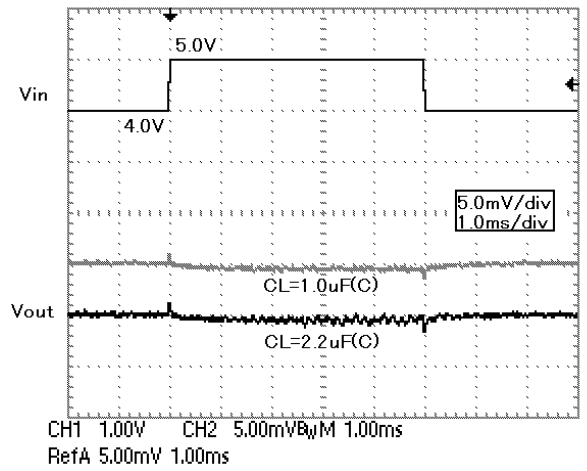

11.7 Output noise

■ Vout vs Noise

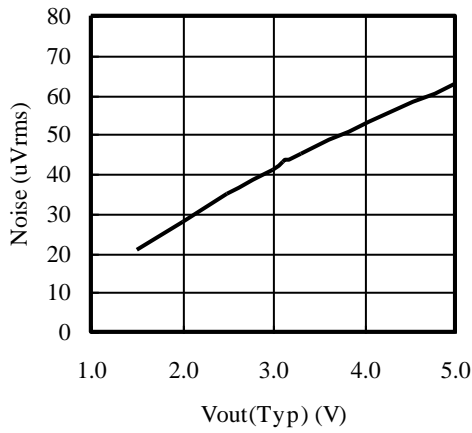

Test conditions

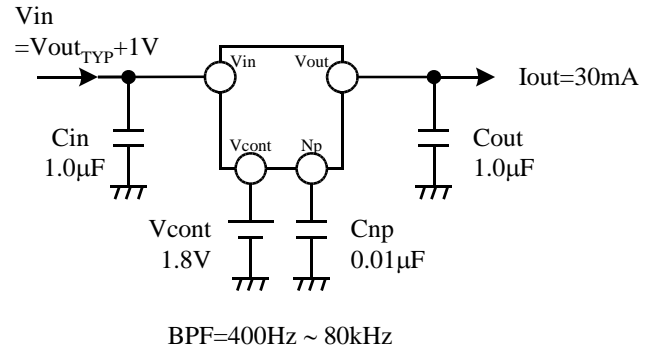

■ Cnp vs Noise

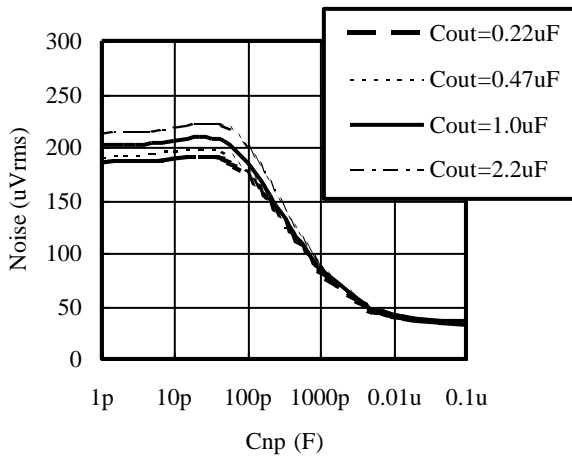

■ Iout vs Noise

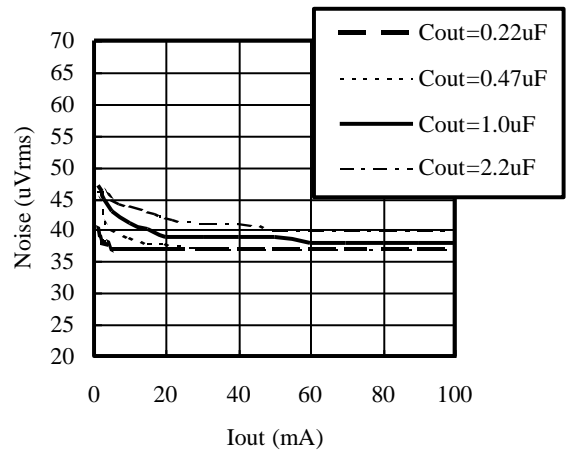

Increase Cnp to decrease the noise. The recommended Cnp capacitance is 0.01μF ~ 0.1μF. The amount of noise increases with the higher output voltages.

11.8 Stability

Linear regulators require input and output capacitors in order to maintain the regulator's loop stability. If 0.22 μ F or larger capacitor is connected to the output pin, the IC provides stable operation at any voltage ($1.3\text{V} \leq V_{\text{outTYP}} \leq 5.0\text{V}$). (The capacitor must be larger than 0.22 μ F at all temperature and voltage range.)

If the capacitor with high Equivalent Series Resistance (ESR) is used, such as tantalum capacitor etc., the regulator may oscillate. Please select parts with low ESR. Due to the parts are uneven, please enlarge the capacitance as much as possible. With larger capacity, the output noise decreases more. In addition, the response to the load change, etc. can be improved. The IC won't be damaged by enlarging the capacity. A recommended value of the application is $C_{\text{in}} = C_{\text{out}} \geq 0.47\mu\text{F}$ Ceramic Capacitance.

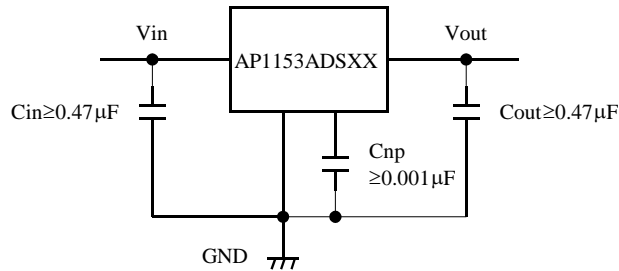
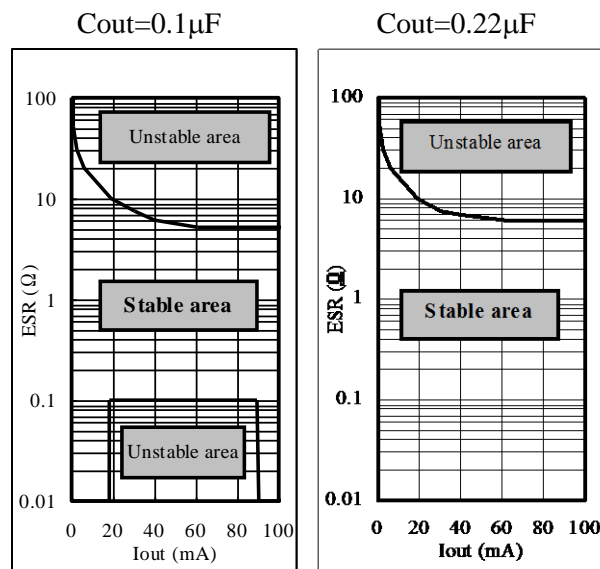

Figure 2. Recommended value



$$1.5\text{V} \leq V_{\text{outTYP}} \leq 5.0\text{V}$$

Figure 3. Stable operation area, Output current and ESR

Figure 3 shows stable operation with a ceramic capacitor of 0.22 μ F. Since it may oscillate if ESR is large, we recommend using ceramic capacitor. The stability of the regulator improves with larger output capacitor (the stable operation area extends.) Please use the capacitor with larger capacitance as possible.

For evaluation

Kyocera: CM05B104K10AB, CM05B224K10AB, CM105B104K16A, CM105B224K16A, CM21B225K10A

Murata: GRM36B104K10, GRM42B104K10, GRM39B104K25, GRM39B224K10, GRM39B105K6.3

The input capacitor is necessary in case the battery voltage drops, the power supply impedance increases, or the distance to the power supply is long. One input capacitor might be necessary for each IC or for several ICs. It depends on circuit condition. Please confirm the stability by each circuit.

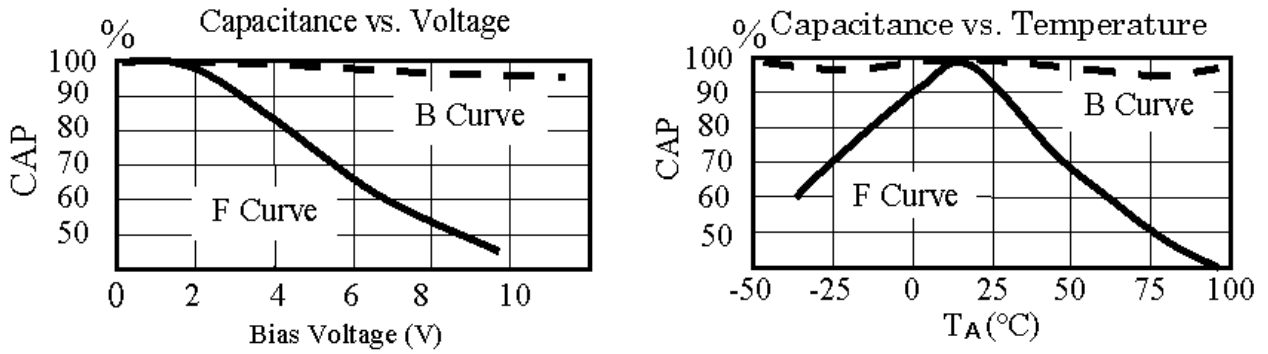

Figure 4. Example Ceramic Capacitance vs. Bias Voltage, Temperature

Generally, a ceramic capacitor has both temperature characteristic and voltage characteristic. Please consider both characteristics when selecting the part. The B curves are the recommend characteristics.

11.9 Operating Region and Power Dissipation

The power dissipation of the device depends on the junction temperature. Therefore, the package dissipation is assumed to be an internal limitation. The package itself does not have enough heat radiation characteristic due to the small size. Heat runs away by mounting IC on PCB. This value changes by the material, copper pattern etc. of PCB.

The overheating protection operates when there is a lot of loss inside the regulator (Ambient temperature high, heat radiation bad, etc.). The output current and the output voltage will drop when the protection circuit operates. When joint temperature (T_j) reaches the set temperature, IC stops the operation. However, operation begins at once when joint temperature (T_j) decreases.

The thermal resistance when mounted on PCB

The chip junction temperature during operation is shown by $T_j = \theta_{JA} \times P_d + T_a$. Junction temperature (T_j) is limited around 140°C by the thermal protection circuit. P_d is the value when the overheating protection circuit starts operation.

When you assume the ambient temperature to be 25°C,

$$140 = \theta_{JA} \times P_d (\text{W}) + 25$$

$$\theta_{JA} \times P_d = 115$$

$$\theta_{JA} = 115/P_d (\text{°C/W})$$

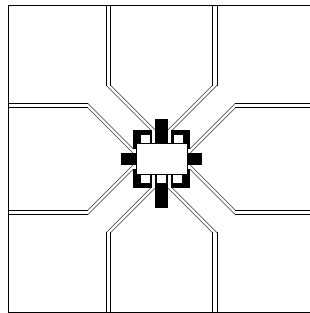

Figure 5. Example PCB layout

PCB Material: Two layer glass epoxy substrate
(x=30mm,y=30mm,t=1.0mm,Copper pattern thickness 35um)

AP1153ADSXX (SOT23-5)

Please derate 5.4mW/°C at $P_d=677\text{mW}$ above 25°C. Thermal resistance (θ_{JA}) is 185°C/W.

Method of obtaining P_d easily

Connect output terminal to GND (short circuited), and measure the input current by increasing the input voltage gradually up to 10V. The input current will reach the maximum output current, but will decrease soon according to the chip temperature rising, and will finally enter the state of thermal equilibrium (natural air cooling).

The input current and the input voltage of this state will be used to calculate the P_d .

$$P_d (\text{mW}) \approx V_{in} (\text{V}) \times I_{in} (\text{mA})$$

When the device is mounted, mostly achieve: 500mW or more

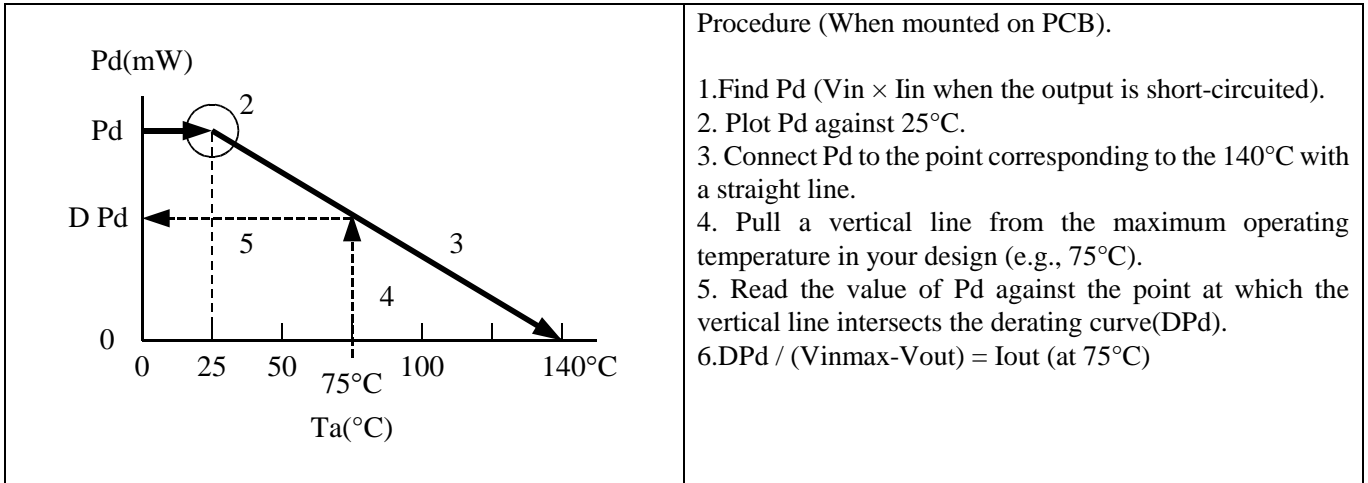

- Procedure (When mounted on PCB).
1. Find Pd ($V_{in} \times I_{in}$ when the output is short-circuited).
 2. Plot Pd against 25°C.
 3. Connect Pd to the point corresponding to the 140°C with a straight line.
 4. Pull a vertical line from the maximum operating temperature in your design (e.g., 75°C).
 5. Read the value of Pd against the point at which the vertical line intersects the derating curve (DPd).
 6. $DPd / (V_{inmax} - V_{out}) = I_{out}$ (at 75°C)

The maximum output current at the highest operating temperature will be $I_{out} \approx DPd / (V_{inmax} - V_{out})$. Please use the device at low temperature with better radiation. The lower temperature provides better quality.

11.10 ON/OFF Control

It is recommended to turn the regulator off when the circuit following the regulator is not operating. A design with small electric power loss can be implemented. Because the control current is small, it is possible to control it directly by CMOS logic.

Control Terminal Voltage (Vcont)	ON/OFF State
$V_{cont} > 1.8V$	ON
$V_{cont} < 0.35V$	OFF

Parallel Connected ON/OFF Control

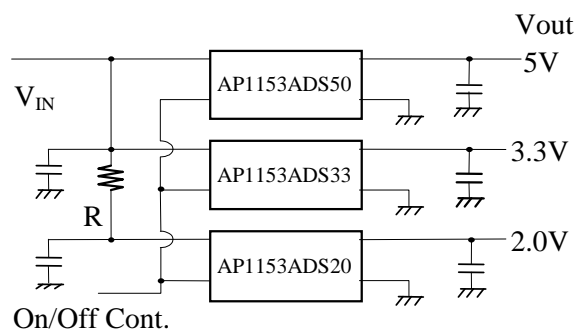

Figure 6. Parallel Connection Example

Figure 6 shows the multiple regulators being controlled by a single ON/OFF control signal. There is fear of overheating, because the power loss of the low voltage side (AP1153ADS20) is large. The series resistor (R) is put in the input line of the low output voltage regulator in order to prevent over-dissipation. The voltage dropped across the resistor reduces the large input-to-output voltage across the regulator, reducing the power dissipation in the device. When the thermal sensor works, a decrease of the output voltage, oscillation, etc. may be observed.

11.11 Noise Bypass

The noise characteristics depend on the capacitance on the Np terminal. A standard value is $C_{np}=0.001\mu\text{F}$. Increase C_{np} in a design with important output noise requirements. The IC will not be damaged even the capacitor value is increased. The on/off switching speed changes depending on the Np terminal capacitance. The switching speed slows when the capacitance is large.

11.12 The notes of the evaluation when output terminal is short-circuit to GND

By the resonance phenomenon by C_{out} (C ingredient) and the short circuit line (L ingredient), which are attached to an output terminal, an output terminal changes with minus potential. In order that Parasitism T_r arises within the IC, and a latch rise phenomenon may occur within IC when the worst if it goes into an output terminal's minus side, it results in damage by fire (white smoke) and breakage of a package. ($f_0 = 1 / 2\pi\sqrt{L C}$)

The above-mentioned resonance phenomenon appears notably in a ceramic capacitor with the small ESR value, etc. A resonance phenomenon can be reduced by connecting resistance (around 2ohms or more) in series with a short circuit line. Thereby, the latch rise phenomenon within IC can be prevented.

Generally, when using tantalum or large electrolysis capacitor, the influence of resonance phenomenon can be reduced due to the large ESR (2ohms or more).

12. Definition of term

Relating Characteristic

Note Each characteristics will be measured in a short period not to be influenced by joint temperature (T_j).

- Output voltage (V_{out})
The output voltage is specified with $V_{in} = V_{outTYP} + 1V$ and $I_{out} = 5mA$
- Output current (I_{out})
Output current, which can be used continuously (It is the range where overheating protection of the IC does not operate.)
- Peak maximum output current ($I_{outPEAK}$)
The rated output current is specified under the condition where the output voltage drops 90% by increasing the output current, compared to the value specified at $V_{in} = V_{outTYP} + 1V$.
- Dropout voltage (V_{drop})
It is an I/O voltage difference when the circuit stops the stable operation by decreasing the input voltage. It is measured when the output voltage drops 100mV from its nominal value by decreasing the input voltage gradually.
- Line Regulation (LinReg)
It is the fluctuations of the output voltage value when the input voltage is changed.
- Load Regulation (LoaReg)
It is the fluctuations of the output voltage value when the input voltage is assumed to be $V_{outTYP} + 1V$, and the load current is changed.
- Ripple Rejection (R.R)
Ripple rejection is the ability of the regulator to attenuate the ripple content of the input voltage at the output. It is measured with the condition of $V_{in} = V_{out} + 1.5V$. Ripple rejection is the ratio of the ripple content between the output vs input and is expressed in dB.
- Standby current ($I_{standby}$)
It is an input current, which flows to the control terminal, when the IC is turned off.

Relating Protection Circuit

- Over Current Protection
It is a function to protect the IC by limiting the output current when excessive current flows to IC, such as the output is connected to GND, etc.
- Thermal Protection
It protects the IC not to exceed the permissible power consumption of the package in case of large power loss inside the regulator. The output is turned off when the chip reaches around $140^{\circ}C$, but it turns on again when the temperature of the chip decreases.
- Reverse Voltage Protection
Reverse voltage protection prevents damage due to the output voltage being higher than the input voltage. This fault condition can occur when the output capacitor remains charged and the input is reduced to zero, or when an external voltage higher than the input voltage is applied to the output side. Generally, a LDO regulator has a diode in the input direction from an output. If an input falls from an output in an input-GND short circuit etc. and this diode turns on, current will flow for an input terminal from an output terminal. In the case of excessive current, IC may break. In order to prevent this, it is necessary to connect a Schottky Diode etc. outside. This product is equipped with reverse bias over-current prevention, and excessive current does not flow in to IC. Therefore, no need to connect diode outside.

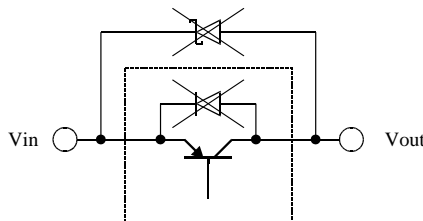

13. Recommended External Circuits

■ External Circuit

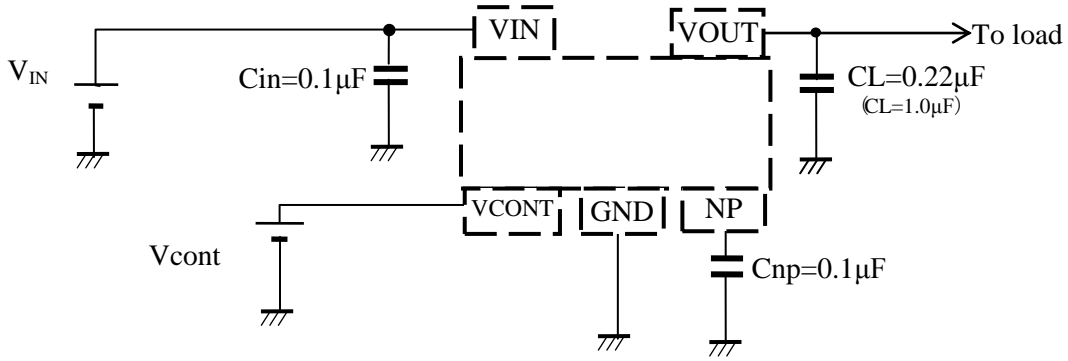

Figure 7. External Circuit

■ Test Circuit

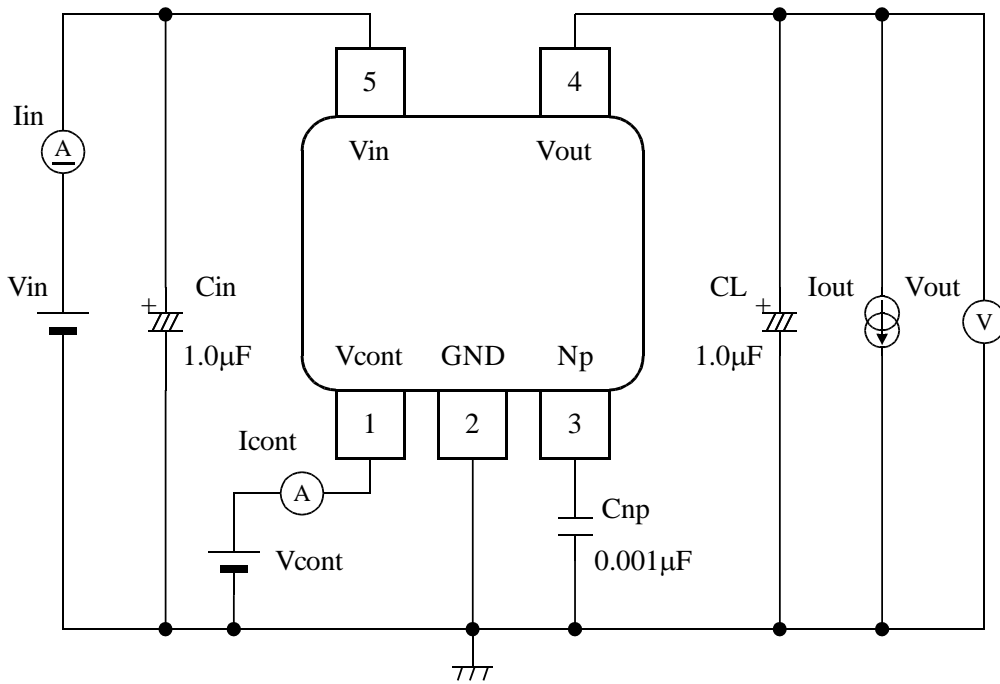
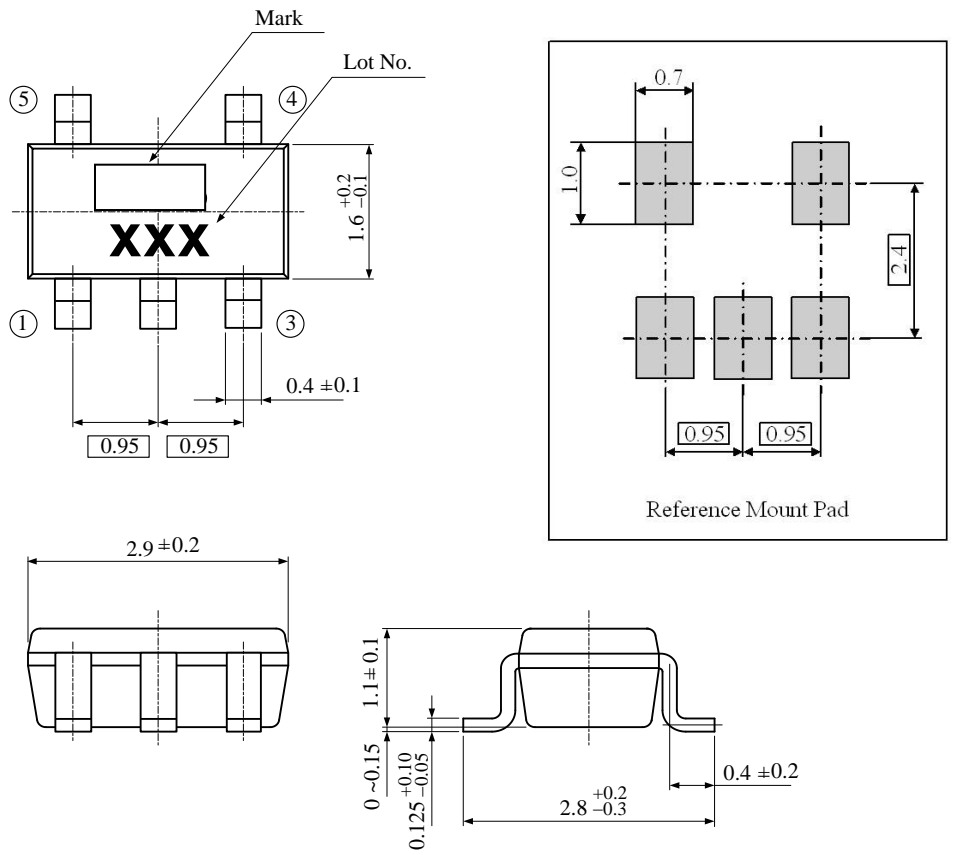

Figure 8. Test Circuit

14. Package

■ Outline Dimensions

Unit: mm



15. Revise History

Date (YY/MM/DD)	Revision	Page	Contents
15/01/21	00	-	First edition

IMPORTANT NOTICE

0. Asahi Kasei Microdevices Corporation (“AKM”) reserves the right to make changes to the information contained in this document without notice. When you consider any use or application of AKM product stipulated in this document (“Product”), please make inquiries the sales office of AKM or authorized distributors as to current status of the Products.
1. All information included in this document are provided only to illustrate the operation and application examples of AKM Products. AKM neither makes warranties or representations with respect to the accuracy or completeness of the information contained in this document nor grants any license to any intellectual property rights or any other rights of AKM or any third party with respect to the information in this document. You are fully responsible for use of such information contained in this document in your product design or applications. **AKM ASSUMES NO LIABILITY FOR ANY LOSSES INCURRED BY YOU OR THIRD PARTIES ARISING FROM THE USE OF SUCH INFORMATION IN YOUR PRODUCT DESIGN OR APPLICATIONS.**
2. The Product is neither intended nor warranted for use in equipment or systems that require extraordinarily high levels of quality and/or reliability and/or a malfunction or failure of which may cause loss of human life, bodily injury, serious property damage or serious public impact, including but not limited to, equipment used in nuclear facilities, equipment used in the aerospace industry, medical equipment, equipment used for automobiles, trains, ships and other transportation, traffic signaling equipment, equipment used to control combustions or explosions, safety devices, elevators and escalators, devices related to electric power, and equipment used in finance-related fields. Do not use Product for the above use unless specifically agreed by AKM in writing.
3. Though AKM works continually to improve the Product’s quality and reliability, you are responsible for complying with safety standards and for providing adequate designs and safeguards for your hardware, software and systems which minimize risk and avoid situations in which a malfunction or failure of the Product could cause loss of human life, bodily injury or damage to property, including data loss or corruption.
4. Do not use or otherwise make available the Product or related technology or any information contained in this document for any military purposes, including without limitation, for the design, development, use, stockpiling or manufacturing of nuclear, chemical, or biological weapons or missile technology products (mass destruction weapons). When exporting the Products or related technology or any information contained in this document, you should comply with the applicable export control laws and regulations and follow the procedures required by such laws and regulations. The Products and related technology may not be used for or incorporated into any products or systems whose manufacture, use, or sale is prohibited under any applicable domestic or foreign laws or regulations.
5. Please contact AKM sales representative for details as to environmental matters such as the RoHS compatibility of the Product. Please use the Product in compliance with all applicable laws and regulations that regulate the inclusion or use of controlled substances, including without limitation, the EU RoHS Directive. AKM assumes no liability for damages or losses occurring as a result of noncompliance with applicable laws and regulations.
6. Resale of the Product with provisions different from the statement and/or technical features set forth in this document shall immediately void any warranty granted by AKM for the Product and shall not create or extend in any manner whatsoever, any liability of AKM.
7. This document may not be reproduced or duplicated, in any form, in whole or in part, without prior written consent of AKM.