



AKD4556-B

AK4556 Evaluation board Rev.1

GENERAL DESCRIPTION

The AKD4556-B is an evaluation board for the AK4556, the 24Bit A/D & D/A converter. The AKD4556-B can evaluate A/D converter and D/A converter separately in addition to loopback mode (A/D→D/A). The AKD4556-B also has the digital audio interface and can achieve the interface with digital audio systems via opt-connector.

■ **Ordering guide**

AKD4556-B --- Evaluation board for AK4556

FUNCTION

- **Digital interface**
 - **DIT (AK4114): optical or BNC**
 - **DIR (AK4114): optical or BNC**
- **10pin header for serial control interface**

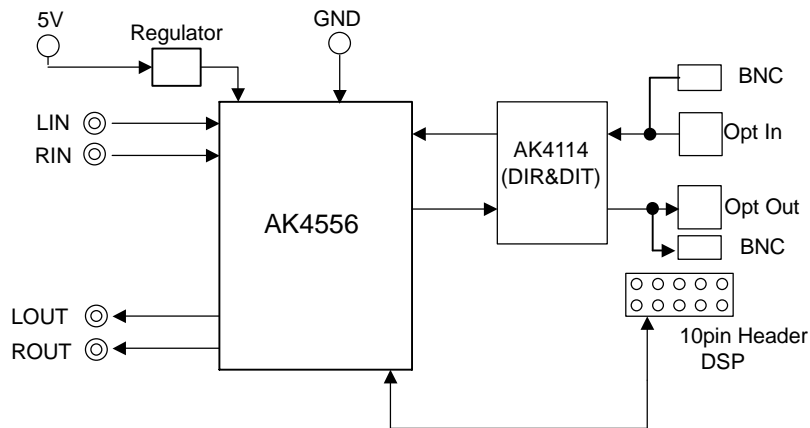

Figure 1. AKD4556-B Block Diagram

* Circuit diagram and PCB layout are attached at the end of this manual.

Evaluation Board Manual

■ Operation sequence

- 1) Set up the power supply lines
[5V] (red) = +5V (3.3V is supplied to the AK4556 , the AK4114 , and the Digital Logic via the regulator.)
[GND] (black) = 0V
- 2) Set up the evaluation modes, jumper pins and DIP switch. (See the followings.)
- 3) Power on
The AK4556 should be reset once bringing SW1 (PDN) “L” upon power-up.

■ The function of the toggle SW.

[SW1] : Resets the AK4556 & AK4114. Keep “H” during normal operation.

■ Evaluation modes

In case of the AK4556 evaluation using the AK4114, it is necessary to correspond to the audio interface format. RX and TX use BNC connector at evaluation of Quad Speed with the AK4114.

Applicable evaluation modes

- (1) Evaluation of Loopback mode using the AK4114 <default>
- (2) Evaluation of DAC using DIR of the AK4114
- (3) Evaluation of ADC using DIT of the AK4114
- (4) All interface signals including master clock are fed externally.

(1) Evaluation of Loopback mode using the AK4114

X'tal oscillator (X1) 24.576MHz is used.

(1-1) Slave mode <Default>

JP1 : Short
 JP2 : Short
 SW3-1 (XTL1) : H
 SW3-2 (XTL0) : L
 SW3-7 (CM0) : H

For the AK4556's sampling speed and audio interface format, refer to Table 3 on page 8.
 For the AK4114's sampling speed and audio interface format, refer to Table 6 and Table 7 on page 9.

Example . Setting of the AK4556 mode 4 (HPF:ON , Audio Format: I²S)

Speed	SW2 AK4556				SW3 AK4114			
	CKS3 (SW2-3)	CKS2 (SW2-4)	CKS1 (SW2-5)	CKS0 (SW2-6)	DIF1 (SW3-3)	DIF0 (SW3-4)	OCKS1 (SW3-5)	OCKS0 (SW3-6)
Normal	L	H	L	L	L	H	H	L
Double	L	H	L	L	L	H	L	L
Quad	L	H	L	L	L	H	H	H

(1-2) Master mode

JP1 : Short
 JP2 : Short
 SW3-1 (XTL1) : H
 SW3-2 (XTL0) : L
 SW3-3 (DIF1) : H
 SW3-4 (DIF0) : H
 SW3-7 (CM0) : H

For the AK4556's sampling speed and audio interface format, refer to Table 3 on page 8.
 For the AK4114's sampling speed and audio interface format, refer to Table 6 and Table 7 on page 9.

Example . Setting of the AK4556 Master mode (HPF:ON , Audio Format: I²S)

Speed	SW2 AK4556				SW3 AK4114	
	CKS3 (SW2-3)	CKS2 (SW2-4)	CKS1 (SW2-5)	CKS0 (SW2-6)	OCKS1 (SW3-5)	OCKS0 (SW3-6)
Normal	H	H	L	H	H	L
Double	H	H	L	L	L	L
Quad	H	H	H	L	H	H

(2) Evaluation of DAC using DIR of the AK4114

DIR generates MCLK , BCLK , LRCK , and SDATA from received data via optical (PORT1) or BNC connector (J6).

(2-1) Slave mode

JP1 : Short
 JP2 : Short
 JP3 : OPT or BNC
 SW3-1 (XTL1) : H
 SW3-2 (XTL0) : H
 SW3-7 (CM0) : L

For the AK4556's sampling speed and audio interface format, refer to Table 3 on page 8.

For the AK4114's sampling speed and audio interface format, refer to Table 6 and Table 7 on page 9.

Example . Setting of the AK4556 mode 4 (HPF:ON , Audio Format: I²S)

Speed	SW2 AK4556				SW3 AK4114			
	CKS3 (SW2-3)	CKS2 (SW2-4)	CKS1 (SW2-5)	CKS0 (SW2-6)	DIF1 (SW3-3)	DIF0 (SW3-4)	OCKS1 (SW3-5)	OCKS0 (SW3-6)
Nomal	L	H	L	L	L	H	H	L
Double	L	H	L	L	L	H	L	L
Quad	L	H	L	L	L	H	H	H

(2-2) Master mode

JP1 : Short
 JP2 : Short
 JP3 : OPT or BNC
 SW3-1 (XTL1) : H
 SW3-2 (XTL0) : H
 SW3-3 (DIF1) : H
 SW3-4 (DIF0) : H
 SW3-7 (CM0) : L

For the AK4556's sampling speed and audio interface format, refer to Table 3 on page 8.

For the AK4114's sampling speed and audio interface format, refer to Table 6 and Table 7 on page 9.

Example . Setting of the AK4556 Master mode (HPF:ON , Audio Format: I²S)

Speed	SW2 AK4556				SW3 AK4114	
	CKS3 (SW2-3)	CKS2 (SW2-4)	CKS1 (SW2-5)	CKS0 (SW2-6)	OCKS1 (SW3-5)	OCKS0 (SW3-6)
Normal	H	H	L	H	H	L
Double	H	H	L	L	L	L
Quad	H	H	H	L	H	H

(3) Evaluation of ADC using DIT of the AK4114

Optical (PORT2) or BNC (J7) connector is used. DIT generates audio bi-phase signal.

(3-1) Slave mode

(3-1-1) When using the AK4114's PLL

Optical (PORT1) or BNC (J6) connector provides access to the bi-phase signal generated by the AK4114.

- JP1 : Short
- JP2 : Short
- JP3,JP4 : OPT or BNC
- SW3-1 (XTL1) : H
- SW3-2 (XTL0) : H
- SW3-7 (CM0) : L

(3-1-2) When using X'tal oscillator (X1) 24.576MHz

- JP1 : Short
- JP2 : Short
- JP4 : OPT or BNC
- SW3-1 (XTL1) : H
- SW3-2 (XTL0) : L
- SW3-7 (CM0) : H

For the AK4556's sampling speed and audio interface format, refer to Table 3 on page 8.

For the AK4114's sampling speed and audio interface format, refer to Table 6 and Table 7 on page 9.

Example . Setting of the AK4556 Mode 8 (HPF:ON , Audio Format:LJ)

Speed	SW2 AK4556				SW3 AK4114			
	CKS3 (SW2-3)	CKS2 (SW2-4)	CKS1 (SW2-5)	CKS0 (SW2-6)	DIF1 (SW3-3)	DIF0 (SW3-4)	OCKS1 (SW3-5)	OCKS0 (SW3-6)
Normal	H	L	L	L	L	L	H	L
Double	H	L	L	L	L	L	L	L
Quad	H	L	L	L	L	L	H	H

(3-2) Master mode

(3-2-1) When using the AK4114's PLL

Optical (PORT1) or BNC (J6) connector provides access to the bi-phase signal generated by the AK4114.

- JP1 : Short
- JP2 : Short
- JP3,JP4 : OPT or BNC
- SW3-1 (XTL1) : H
- SW3-2 (XTL0) : H
- SW3-3 (DIF1) : H
- SW3-4 (DIF0) : H
- SW3-7 (CM0) : L

(3-2-2) When using X'tal oscillator (X1) 24.576MHz

- JP1 : Short
- JP2 : Short
- JP4 : OPT or BNC
- SW3-1 (XTL1) : H
- SW3-2 (XTL0) : L
- SW3-3 (DIF1) : H
- SW3-4 (DIF0) : H
- SW3-7 (CM0) : H

For the AK4556's sampling speed and audio interface format, refer to Table 3 on page 8.

For the AK4114's sampling speed and audio interface format, refer to Table 6 and Table 7 on page 9.

Example . Setting of the AK4556 Master Mode (HPF:ON , Audio Format: I²S)

Speed	SW2 AK4556				SW3 AK4114	
	CKS3 (SW2-3)	CKS2 (SW2-4)	CKS1 (SW2-5)	CKS0 (SW2-6)	OCKS1 (SW3-5)	OCKS0 (SW3-6)
Normal	H	H	L	H	H	L
Double	H	H	L	L	L	L
Quad	H	H	H	L	H	H

(4) All interface signals including master clock are fed externally.

PORT3 is used.

(4-1) Slave mode

JP1 : Open
JP2 : Open
SW3-3 (DIF1) : H
SW3-4 (DIF0) : H

In slave mode , the AK4556's sampling speed and audio interface format is set by SW2. See Table 1 on page 8 for possible mode setting.

(4-2) Master mode

JP1 : Open
JP2 : Open
SW3-3 (DIF1) : H
SW3-4 (DIF0) : H

In master mode , the AK4556's sampling speed and audio interface format is set by SW2. See Table 1 on page 8 for possible mode setting.

■ Setting of DIP SW

1. Evaluation mode setting of SW2 (AK4556)

No.	Name	Default
1	DEM1	L
2	DEM0	H
3	CKS3	L
4	CKS2	H
5	CKS1	L
6	CKS0	L

Table 1 . SW2 AK4556 Mode Setting

DEM1	DEM0	Mode
L	L	44.1kHz
L	H	OFF
H	L	48kHz
H	H	32kHz

Table 2 . De-emphasis filter control

Mode	CKS3	CKS2	CKS1	CKS0	HPF	M/S	MCLK	Audio I/F
0	L	L	L	L	ON	Slave	128/192fs (Quad Speed) 256/384fs (Double Speed) 512/768fs (Normal Speed)	LJ/RJ
1	L	L	L	H	ON	Slave	256/384/512/768fs (Normal Speed)	LJ/RJ
2	L	L	H	L	OFF	Slave	128/192fs (Quad Speed) 256/384fs (Double Speed) 512/768fs (Normal Speed)	LJ/RJ
3	L	L	H	H	OFF	Slave	256/384/512/768fs (Normal Speed)	LJ/RJ
4	L	H	L	L	ON	Slave	128/192fs (Quad Speed) 256/384fs (Double Speed) 512/768fs (Normal Speed)	I ² S
5	L	H	L	H	ON	Slave	256/384/512/768fs (Normal Speed)	I ² S
6	L	H	H	L	OFF	Slave	128/192fs (Quad Speed) 256/384fs (Double Speed) 512/768fs (Normal Speed)	I ² S
7	L	H	H	H	OFF	Slave	256/384/512/768fs (Normal Speed)	I ² S
8	H	L	L	L	ON	Slave	128/192fs (Quad Speed) 256/384fs (Double Speed) 512/768fs (Normal Speed)	LJ
9	H	L	L	H	ON	Slave	256/384/512/768fs (Normal Speed)	LJ
10	H	L	H	L	OFF	Slave	128/192fs (Quad Speed) 256/384fs (Double Speed) 512/768fs (Normal Speed)	LJ
11	H	L	H	H	OFF	Slave	256/384/512/768fs (Normal Speed)	LJ
12	H	H	L	L	ON	Master	256fs (Double Speed)	I ² S
13	H	H	L	H	ON	Master	512fs (Normal Speed)	I ² S
14	H	H	H	L	ON	Master	128fs (Quad Speed)	I ² S
15	H	H	H	H	ON	Master	256fs (Normal Speed)	I ² S

Table 3 . AK4556 Mode Setting

In case of the AK4556 evaluation using the AK4114 , LJ/RJ (Mode 0 ~ Mode 3) in Audio I/F does not support.

2. Evaluation mode setting of SW3 (AK4114)

No.	Name	Default
1	XTL1	H
2	XTL0	L
3	DIF1	L
4	DIF0	H
5	OCKS1	L
6	OCKS0	L
7	CM0	H

Table 4 . SW3 AK4114 Mode Setting

XTL1	XTL0	X'tal Frequency
L	L	11.2896 MHz
L	H	12.288 MHz
H	L	24.576 MHz
H	H	OFF

Table 5 . Reference X'tal Frequency

DIF1	DIF0	DAUX	SDTO	LRCK,BCLK
L	L	24bit LJ	24bit LJ	O
L	H	24bit I ² S	24bit I ² S	O
H	H	24bit I ² S	24bit I ² S	I

Table 6. Audio Data Format

OCKS1	OCKS0	MCKO1	X'tal	fs Max	Speed
L	L	256fs	256fs	96kHz	Double
H	L	512fs	512fs	48kHz	Normal
H	H	128fs	128fs	192kHz	Quad

Table 7. Master Clock Output Frequency

CM0	PLL	Clock Souce	SDTO
L	ON	PLL	RX
H	OFF	X'tal	DAUX

Table 8 . Clock Operation Mode

■ Jumper pins set up

[JP1] : MCLK

Short : MCLK is supplied from the AK4114.

Open : MCLK is supplied from PORT3.

[JP2] : SDTI

Short : SDTI is supplied from the AK4114.

Open : SDTI is supplied from PORT3.

[JP3] : RX (DIR)

OPT : Optical connector (PORT1) is used.

BNC : BNC connector (J5) is used.

[JP4] : TX (DIT)

OPT : Optical connector (PORT2) is used.

BNC : BNC connector (J6) is used.

■ Analog input circuit

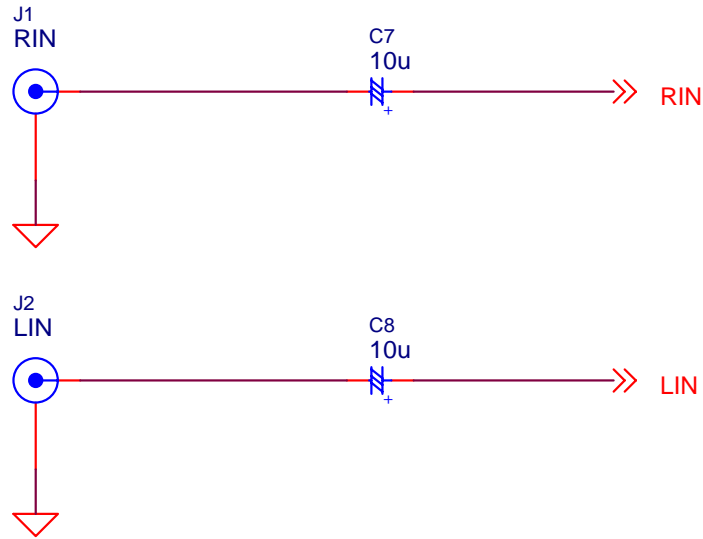

Figure 2. Analog Input Circuit

■ Analog output circuit

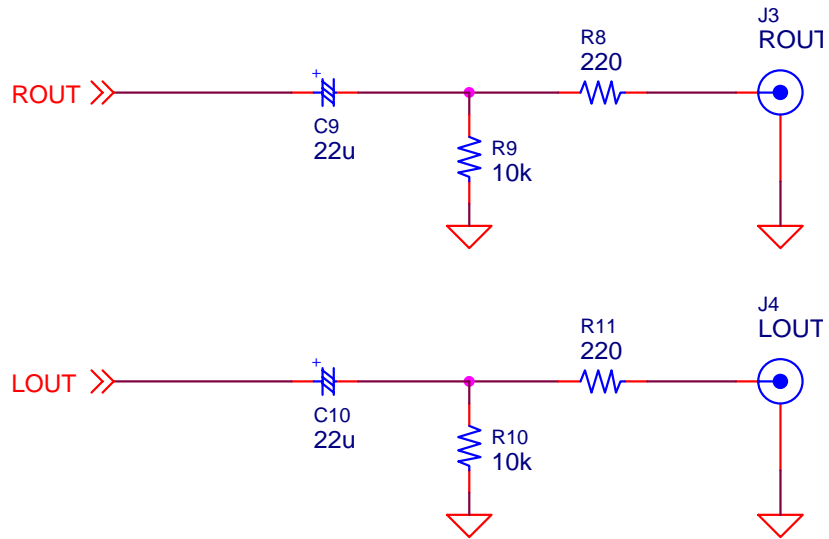

Figure 3. Analog Output Circuit

MEASUREMENT RESULTS

[Measurement condition]

- Measurement unit: Audio Precision, System two Cascade
- Slave Mode
- BCLK: 64fs
- Bit: 24bit
- Measurement Frequency: Nomal Speed : 20Hz ~ 20kHz , Double & Quad Speed : 20Hz ~ 40kHz
- Power Supply: VA=VD=3.3 V
- Temperature: Room
- Input Frequency: 1kHz
- Sampling Frequency: 48kHz , 96kHz , 192kHz

[Measurement Results]

ADC (LIN/RIN) characteristics

Sampling Frequency	Parameter	Condition	Filter	L ch	R ch	Units
48kHz	S / (N+D)	-1dB Input	20kHzLPF	92.2	92.1	dB
	DR	-60dB Input	20kHzLPF	102.4	102.4	dB
	DR	-60dB Input	A-weighted	104.8	104.8	dB
	S/N	No Signal	A-weighted	104.9	104.9	dB
96kHz	S / (N+D)	-1dB Input	40kHzLPF	90.8	90.8	dB
	DR	-60dB Input	40kHzLPF	98.7	98.7	dB
	DR	-60dB Input	A-weighted	104.3	104.3	dB
	S/N	No Signal	A-weighted	104.4	104.4	dB
192kHz	S / (N+D)	-1dB Input	40kHzLPF	90.8	90.8	dB
	DR	-60dB Input	40kHz LPF	98.6	98.6	dB
	DR	-60dB Input	A-weighted	103.8	103.8	dB
	S/N	No Signal	A-weighted	103.9	103.9	dB

DAC (LOUT/ROUT) characteristics

Sampling Frequency	Parameter	Condition	Filter	L [dB]	R [dB]	Units
48kHz	S / (N+D)	0dB Input	20kHzLPF	90.8	90.9	dB
	DR	-60dB Input	20kHzLPF	105.0	105.0	dB
	DR	-60dB Input	A-weighted	107.5	107.5	dB
	S/N	No Signal	A-weighted	107.8	107.8	dB
96kHz	S / (N+D)	0dB Input	40kHzLPF	89.2	89.1	dB
	DR	-60dB Input	40kHzLPF	102.7	102.7	dB
	DR	-60dB Input	A-weighted	107.7	107.7	dB
	S/N	No Signal	A-weighted	107.7	107.7	dB
192kHz	S / (N+D)	0dB Input	40kHzLPF	89.2	89.2	dB
	DR	-60dB Input	40kHz LPF	102.7	102.7	dB
	DR	-60dB Input	A-weighted	107.7	107.7	dB
	S/N	No Signal	A-weighted	107.7	107.7	dB

[Plots]

ADC

fs=48kHz

AKM

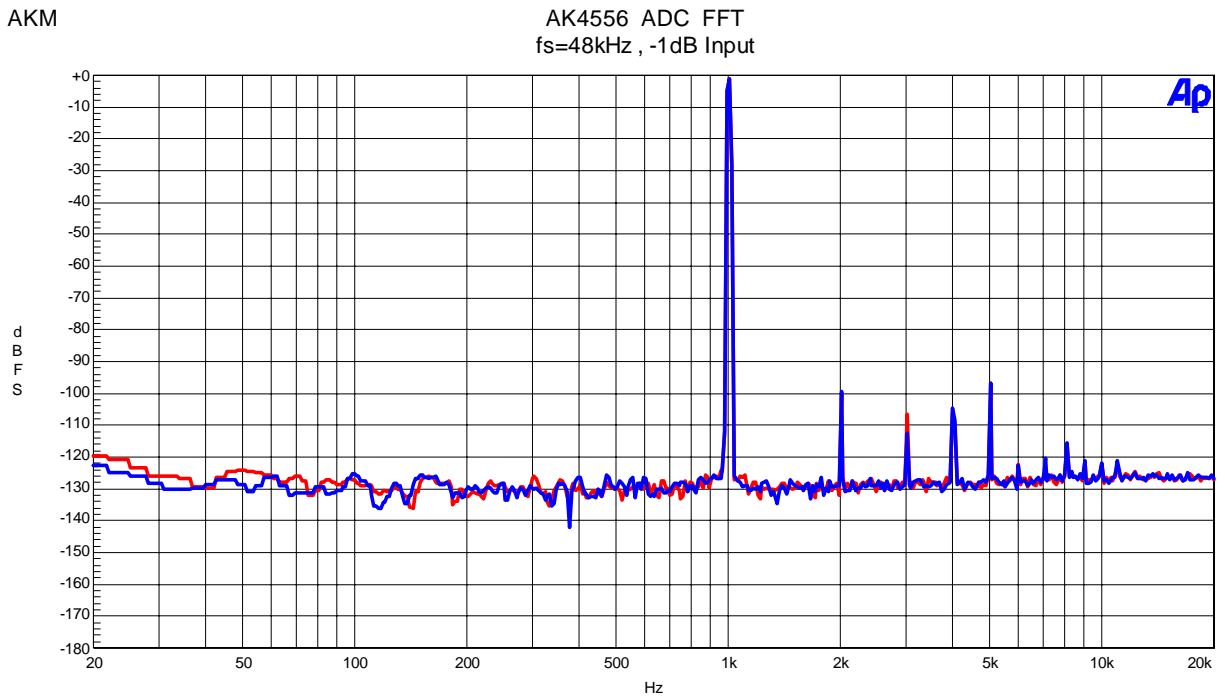

Figure 4. FFT (fin=1kHz , Input Level=-1dBFS)

AKM

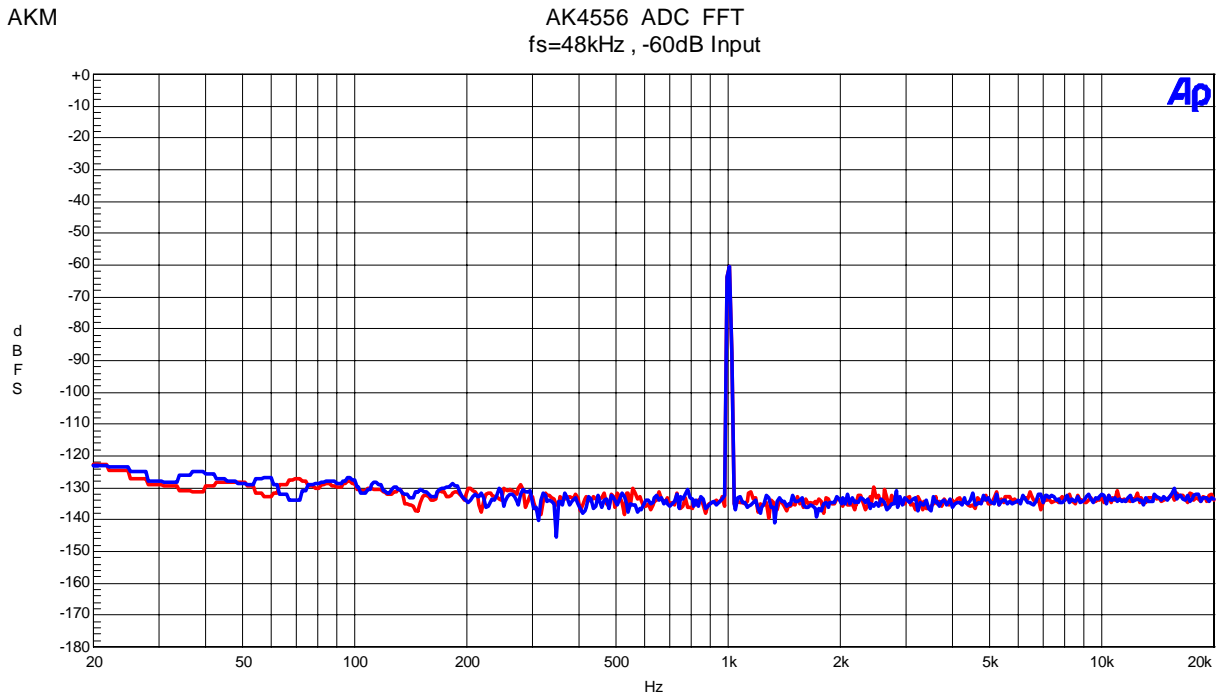

Figure 5. FFT (fin=1kHz , Input Level=-60dBFS)

AKM

AK4556 ADC FFT
fs=48kHz , No Signal

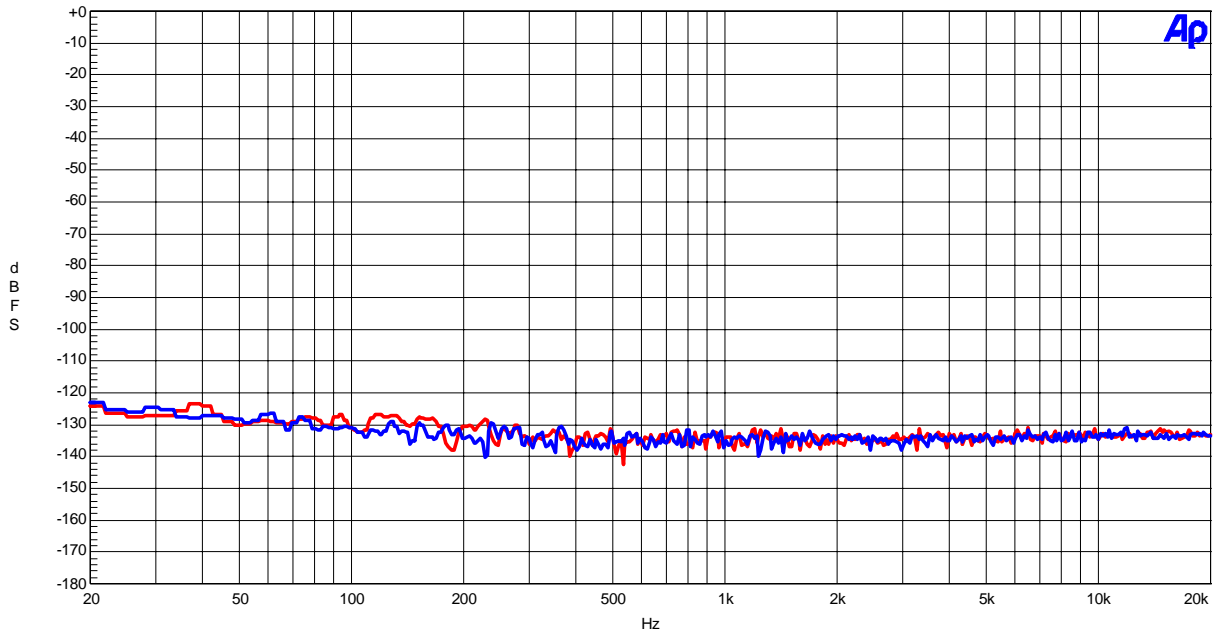

Figure 6. FFT (fin=1kHz , No Signal)

AKM

AK4556 ADC THD + N vs Input Level
fs=48kHz

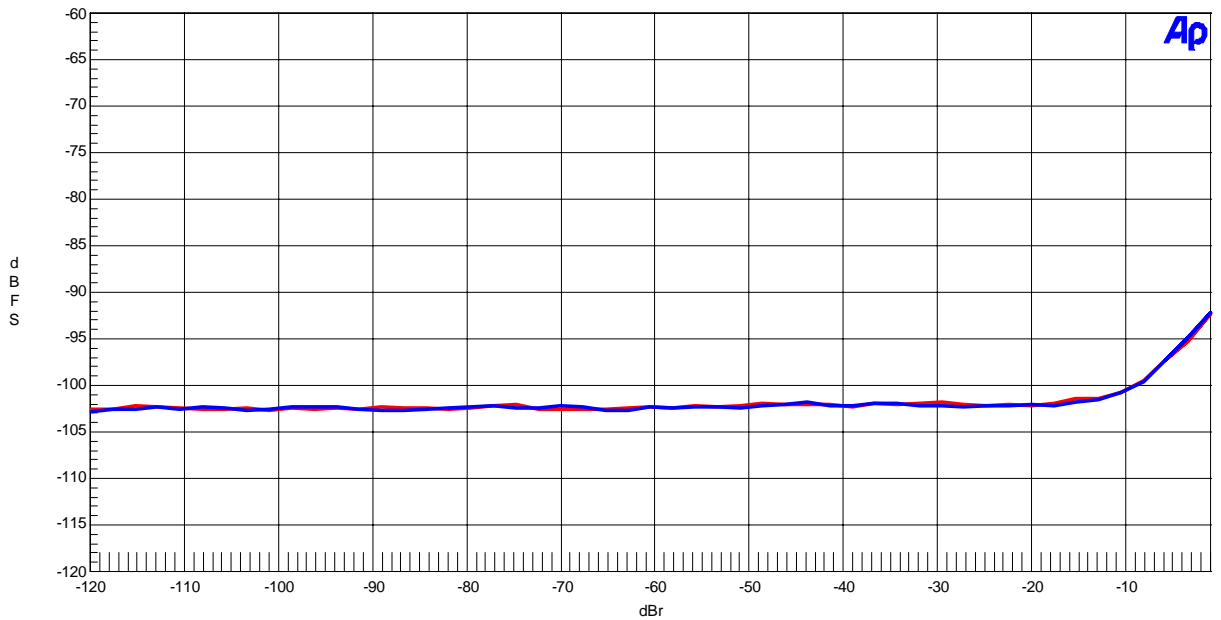

Figure 7. THD+N vs Input Level (fin=1kHz)

AKM

AK4556 ADC THD + N vs Input Frequency
fs=48kHz

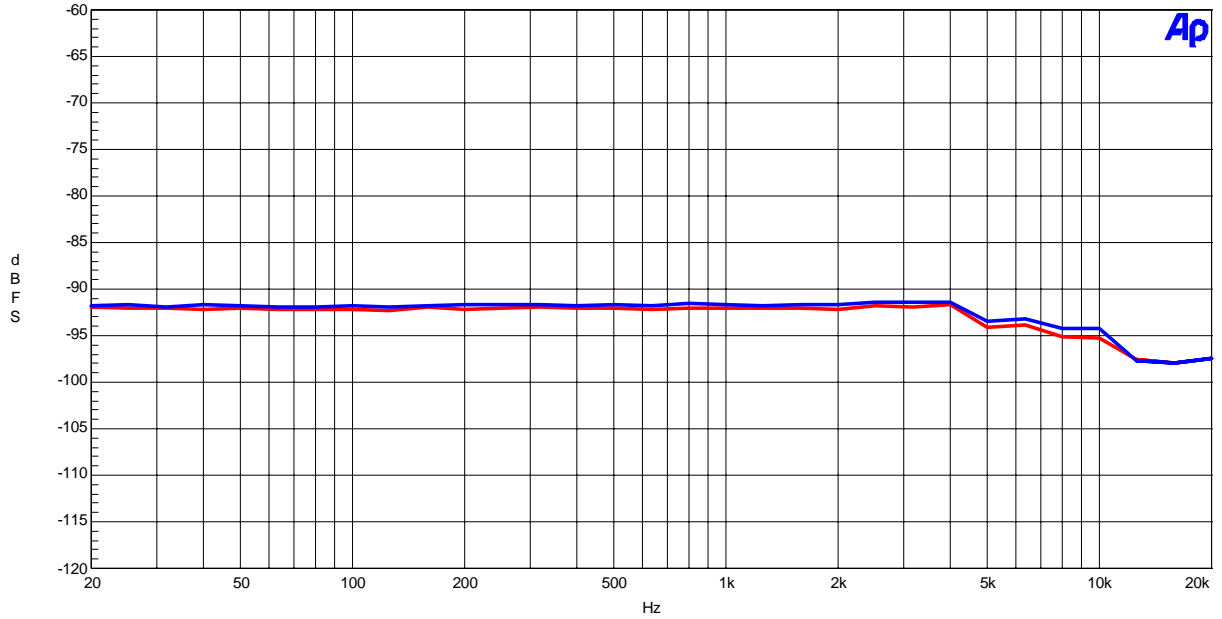

Figure 8. THD+N vs Input Frequency (Input Level =-1dBFS)

AKM

AK4556 ADC Linearity
fs=48kHz

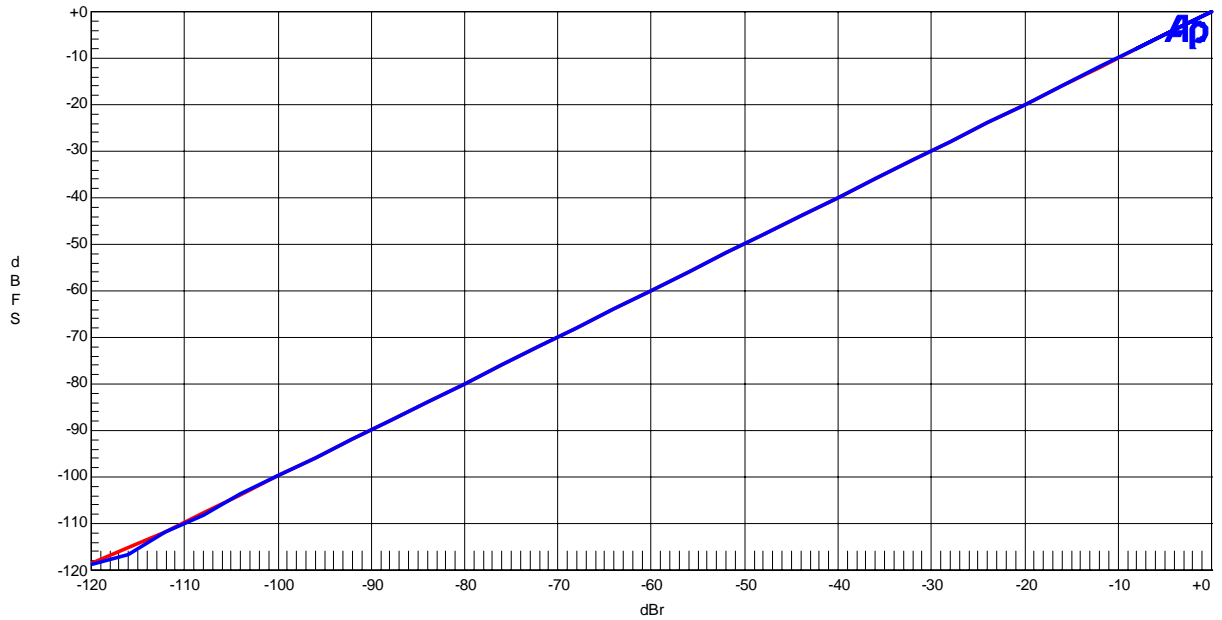

Figure 9. Linearity (fin=1kHz)

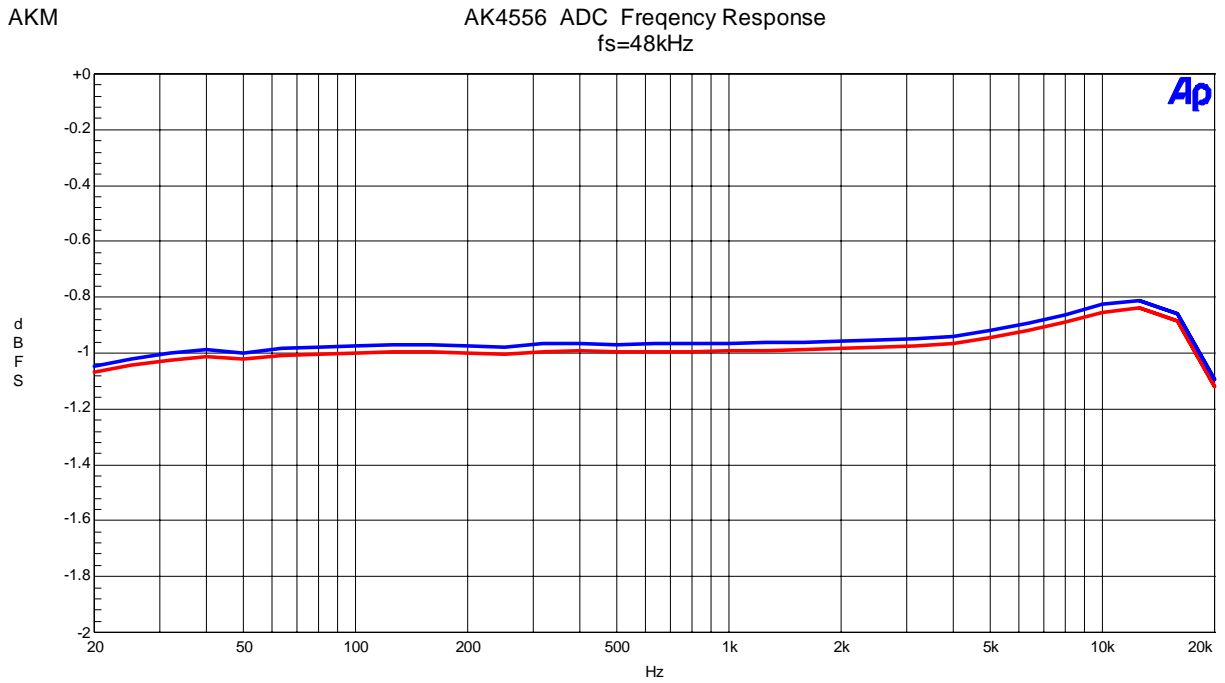

Figure 10. Frequency Response

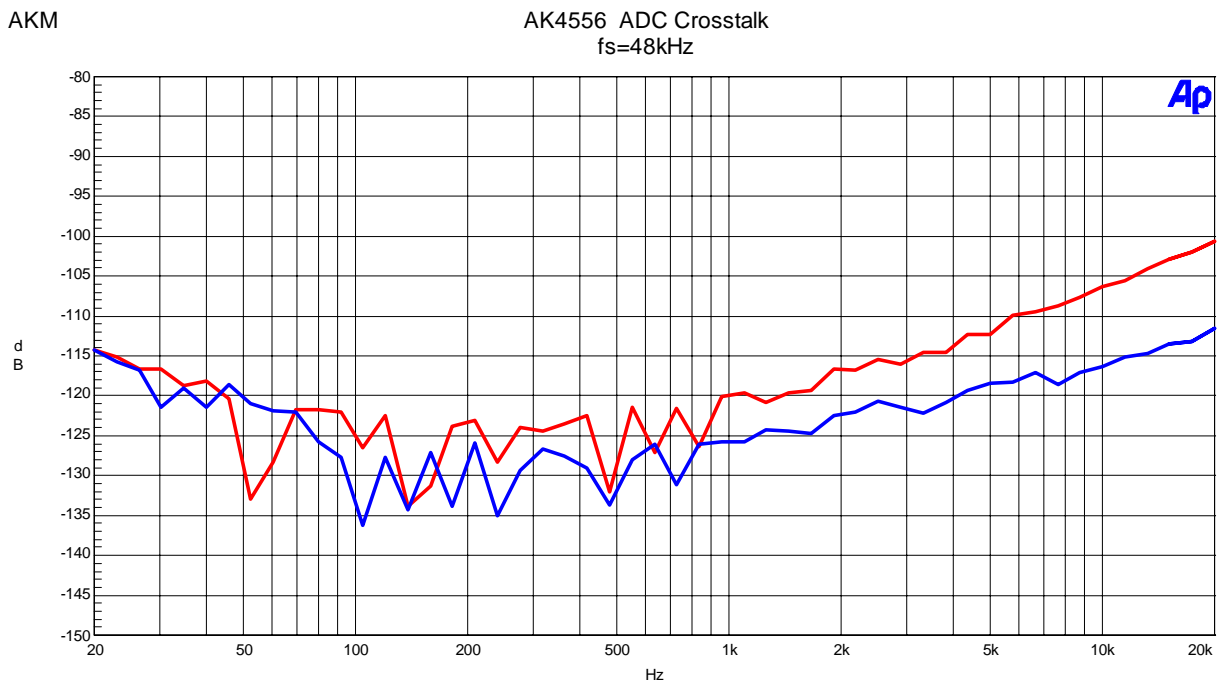

Figure 11. Crosstalk

fs=96kHz

AKM

AK4556 ADC FFT
fs=96kHz , -1dB Input

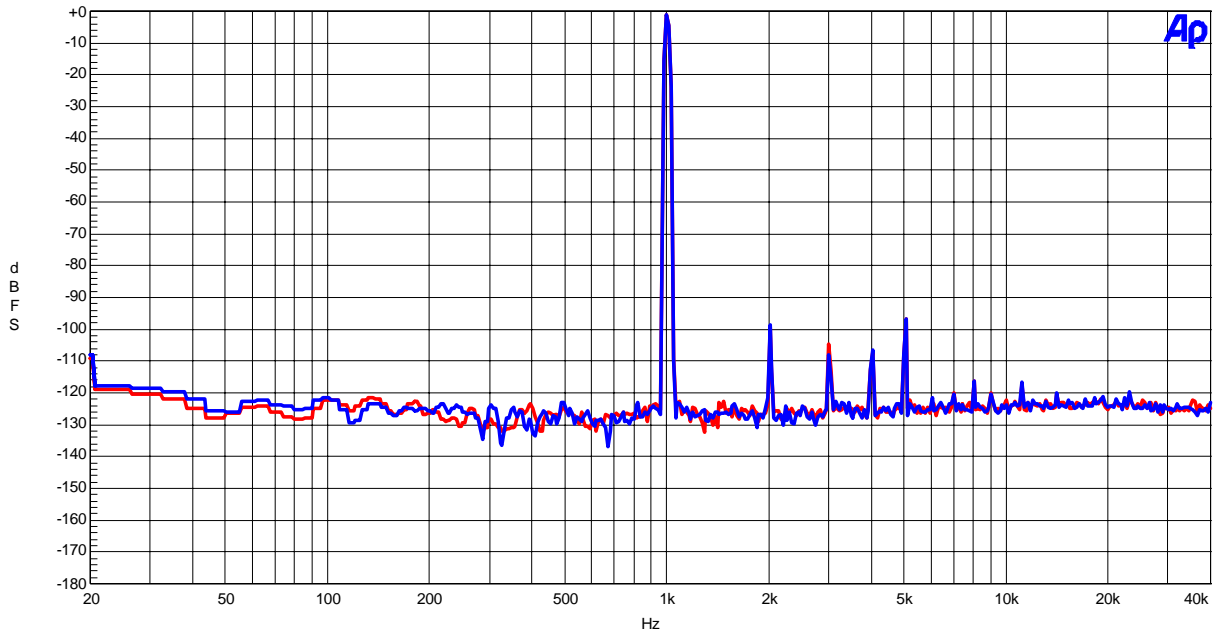

Figure 12. FFT (fin=1kHz , Input Level=-1dBFS)

AKM

AK4556 ADC FFT
fs=96kHz , -60dB Input

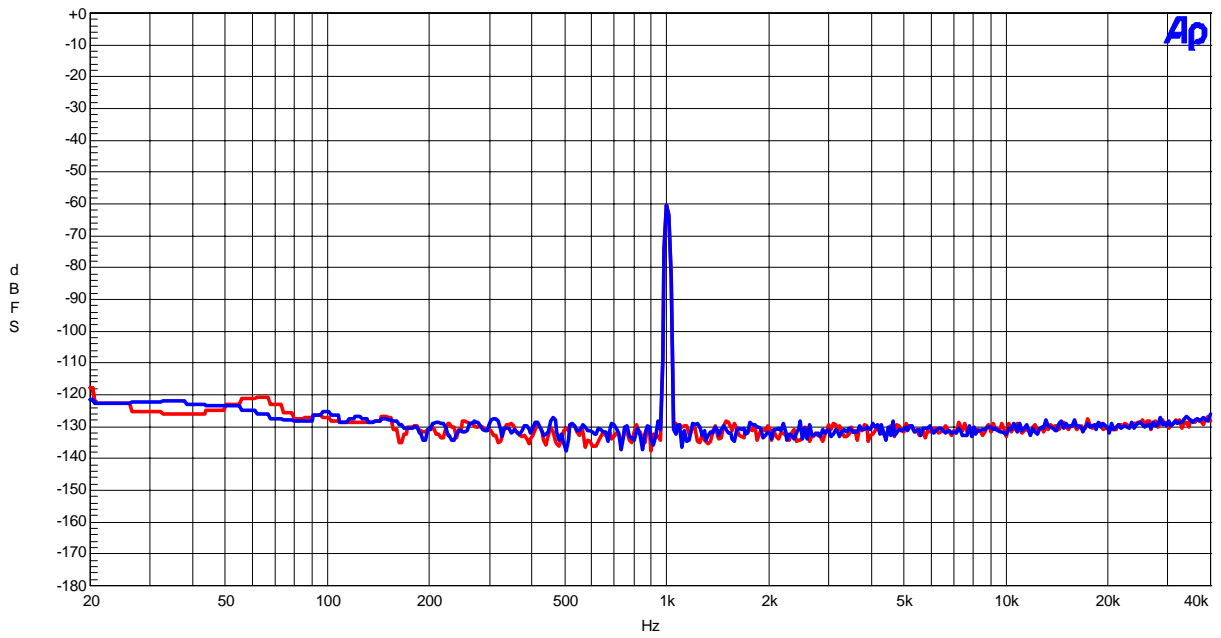

Figure 13. FFT (fin=1kHz , Input Level=-60dBFS)

AKM

AK4556 ADC FFT
fs=96kHz, No Signal

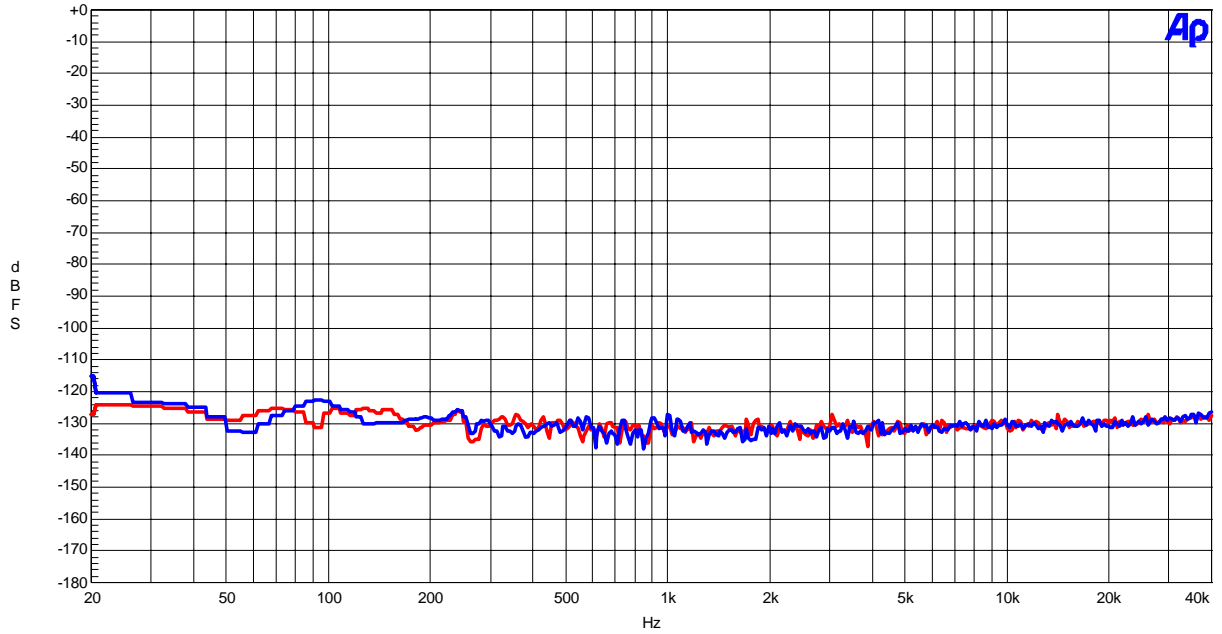

Figure 14. FFT (fin=1kHz, No Signal)

AKM

AK4556 ADC THD + N vs Input Level
fs=96kHz

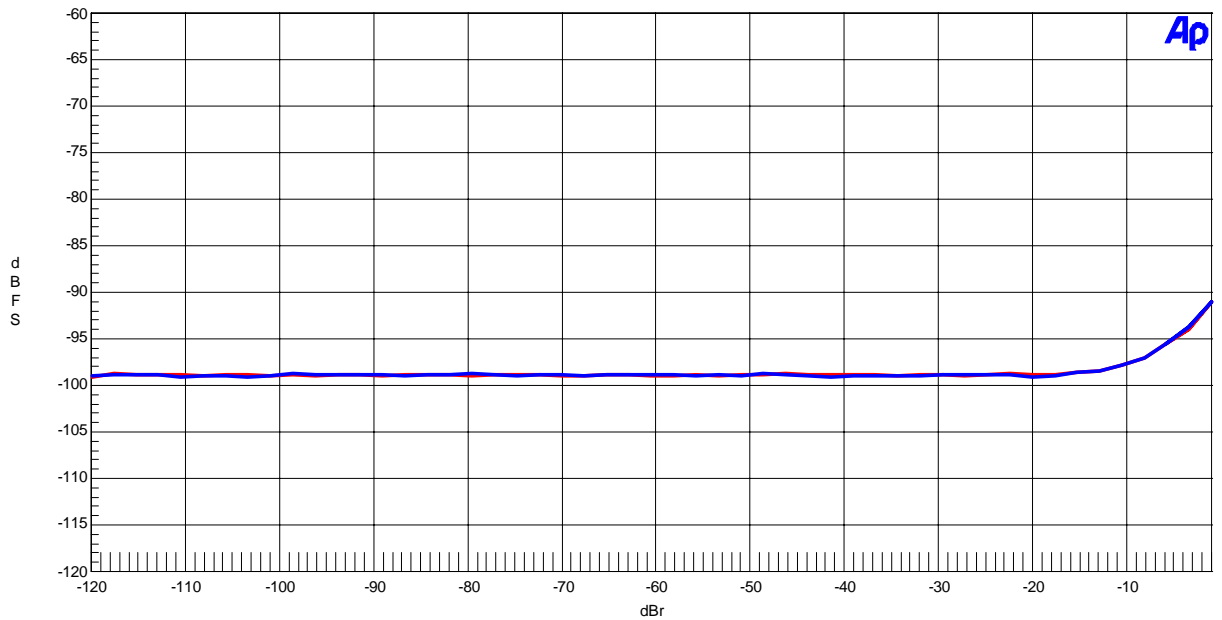

Figure 15. THD+N vs Input Level (fin=1kHz)

AKM

AK4556 ADC THD + N vs Input Frequency
fs=96kHz

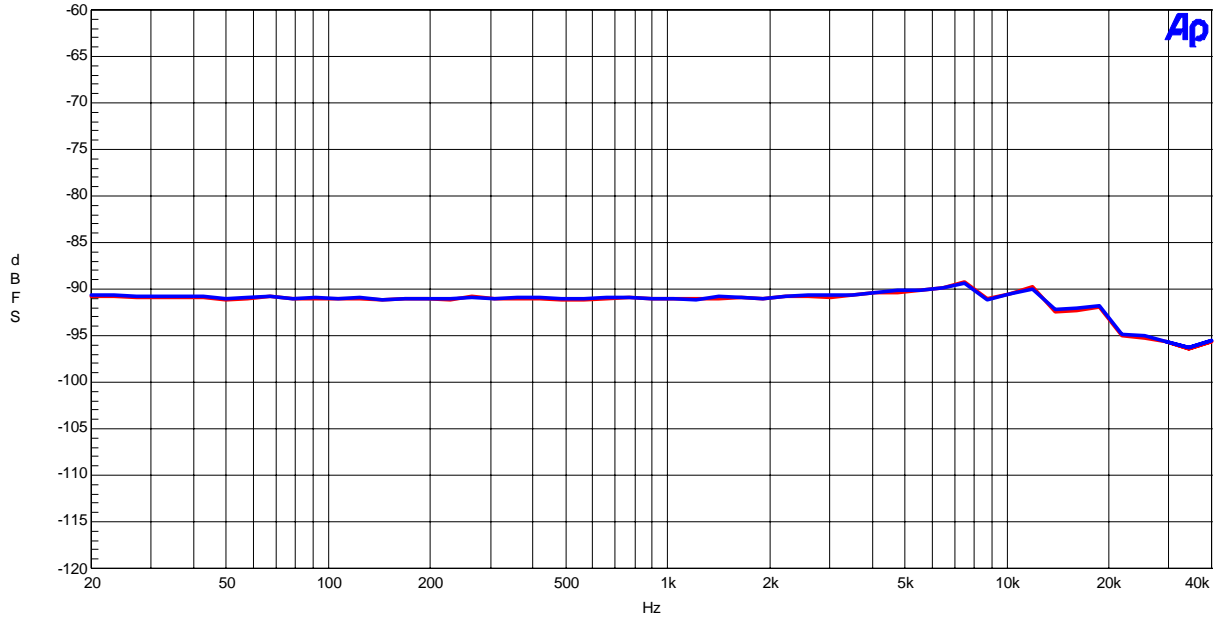

Figure 16. THD+N vs Input Frequency (Input Level =-1dBFS)

AKM

AK4556 ADC Linearity
fs=96kHz

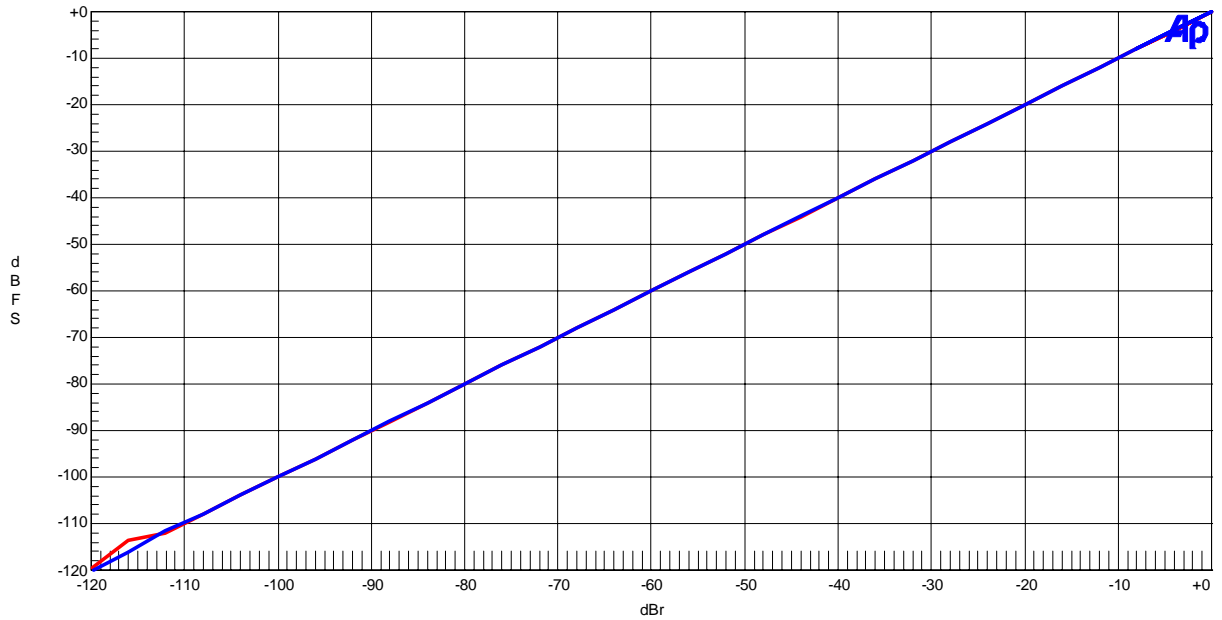

Figure 17. Linearity (fin=1kHz)

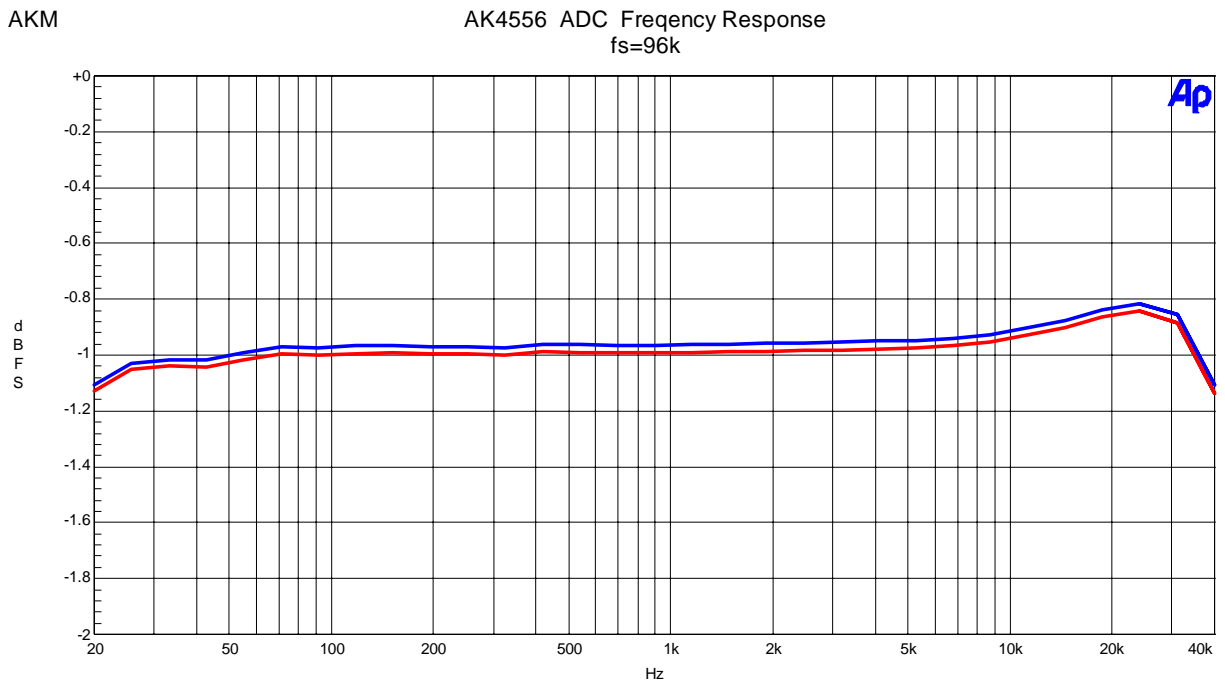

Figure 18. Frequency Response

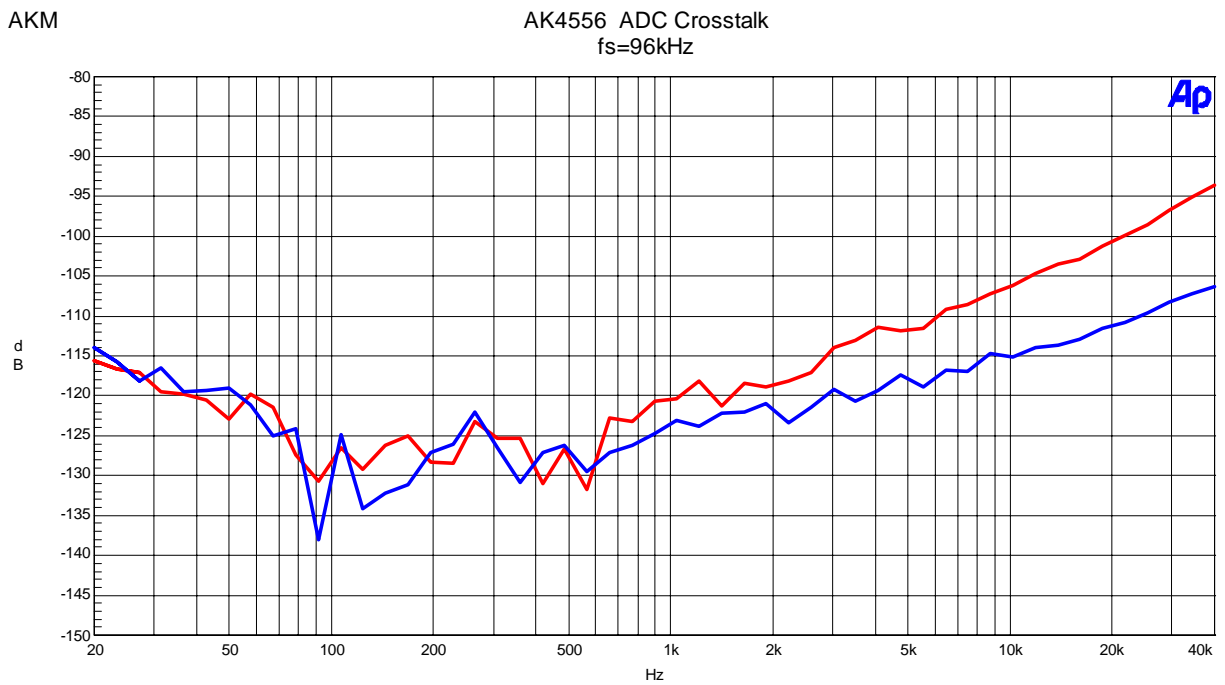

Figure 19. Crosstalk

fs=192kHz

AKM

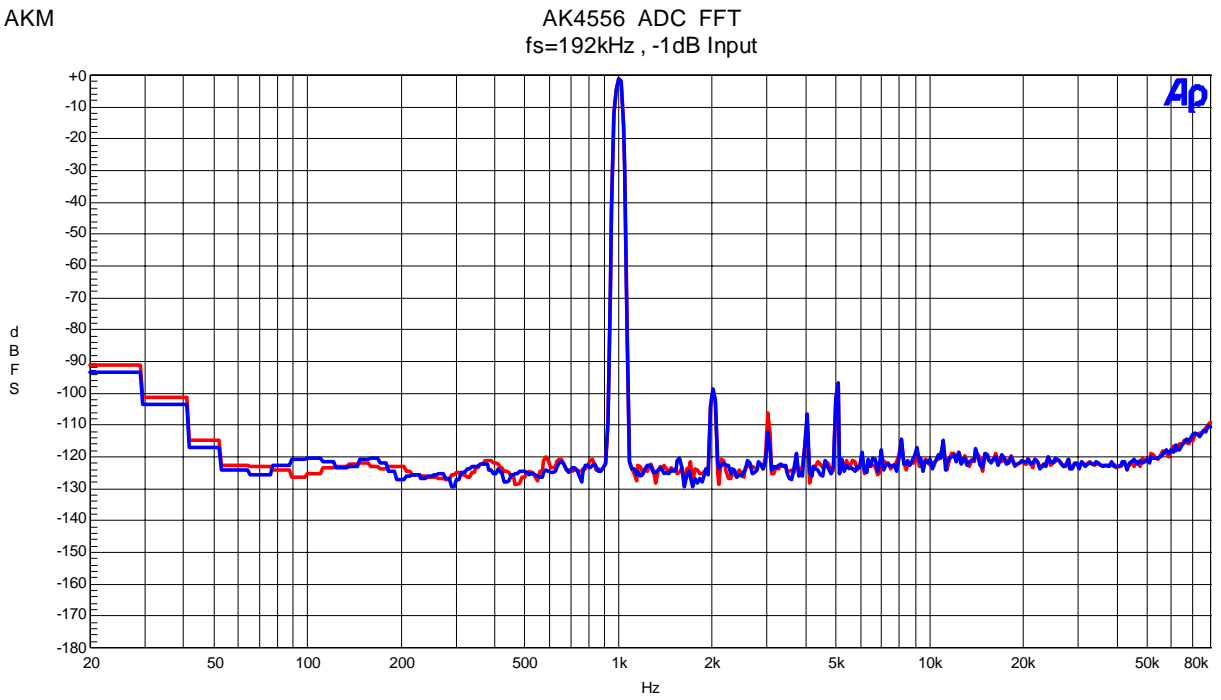

Figure 20. FFT (fin=1kHz , Input Level=-1dBFS)

AKM

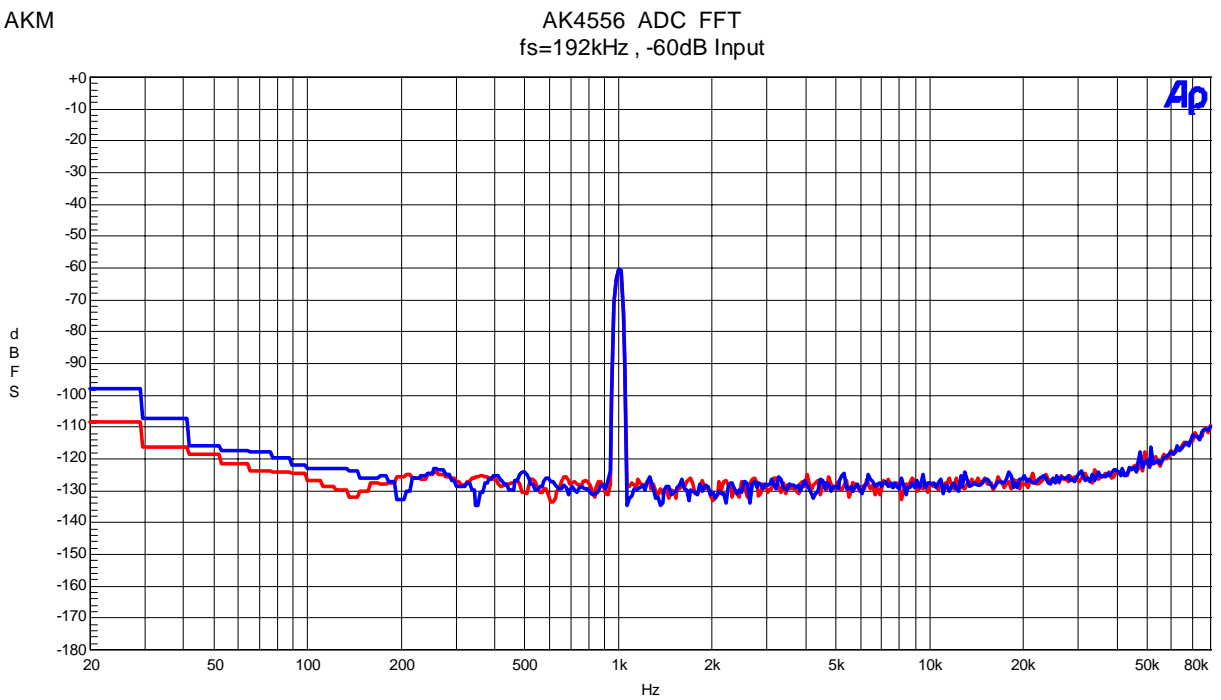

Figure 21. FFT (fin=1kHz , Input Level=-60dBFS)

AKM

AK4556 ADC FFT
fs=192kHz, No Signal

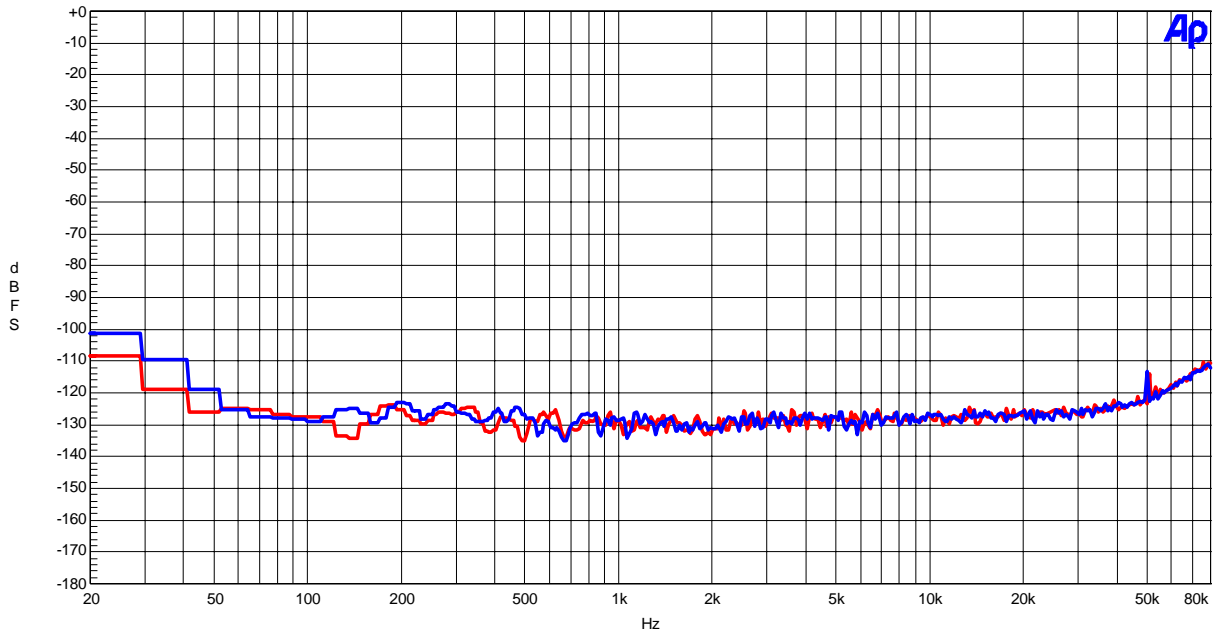

Figure 22. FFT (fin=1kHz, No Signal)

AKM

AK4556 ADC THD + N vs Input Level
fs=192kHz

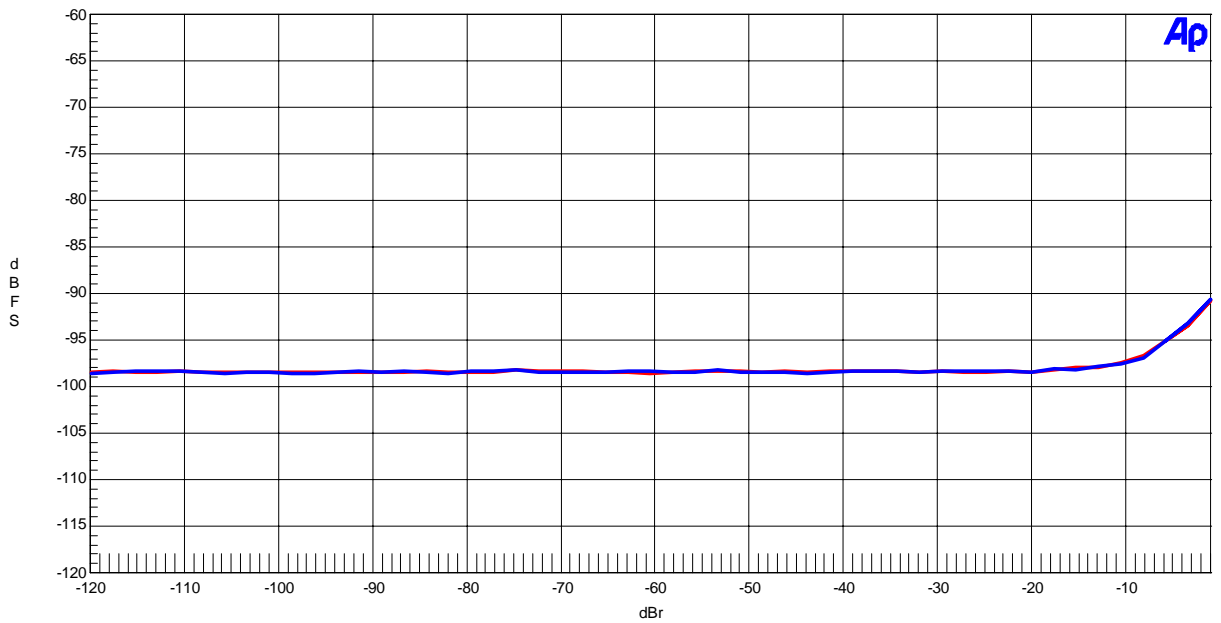

Figure 23. THD+N vs Input Level (fin=1kHz)

AKM

AK4556 ADC THD + N vs Input Frequency
fs=192kHz

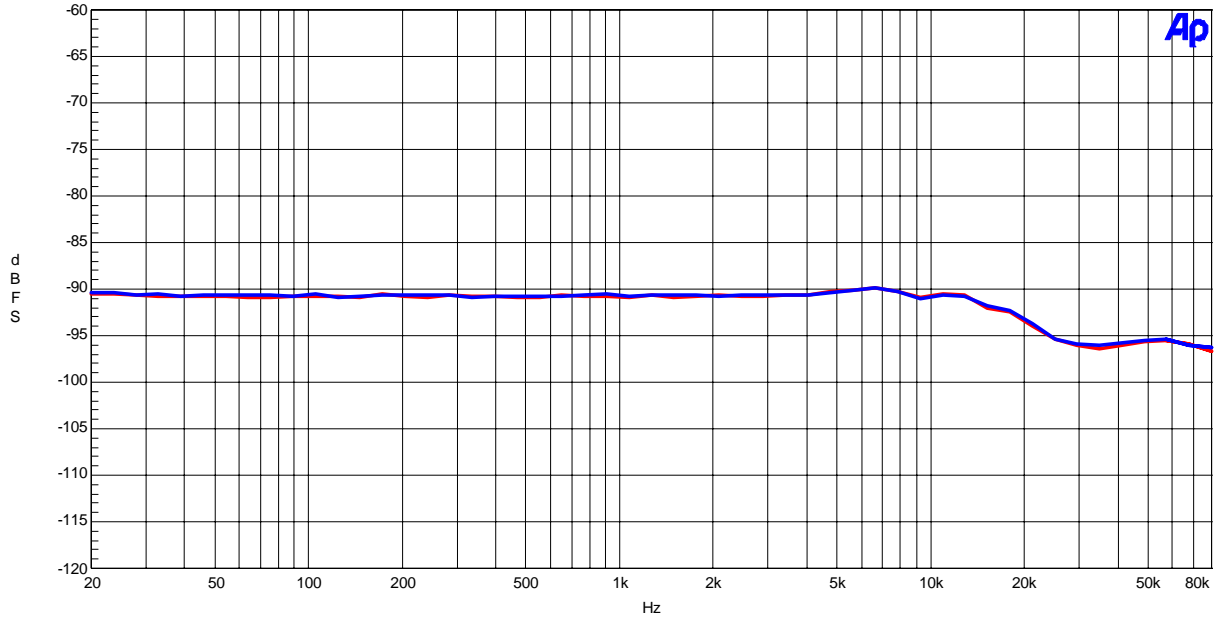

Figure 24. THD+N vs Input Frequency (Input Level =-1dBFS)

AKM

AK4556 ADC Linearity
fs=192kHz

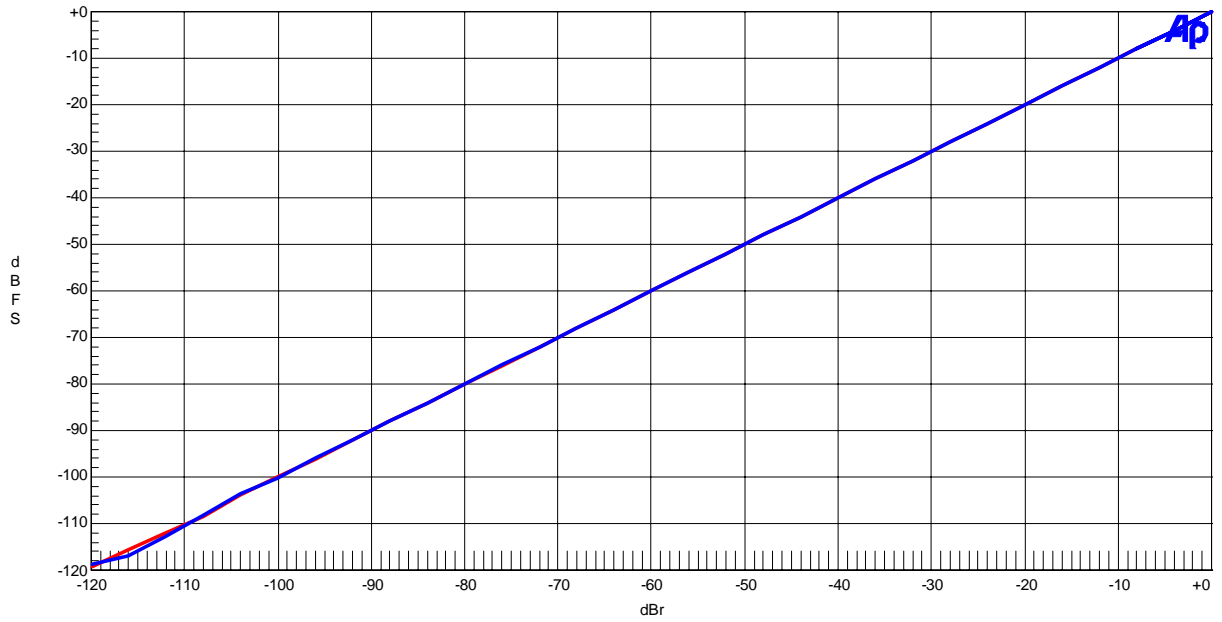

Figure 25. Linearity (fin=1kHz)

AKM

AK4556 ADC Frequency Response
fs=192k

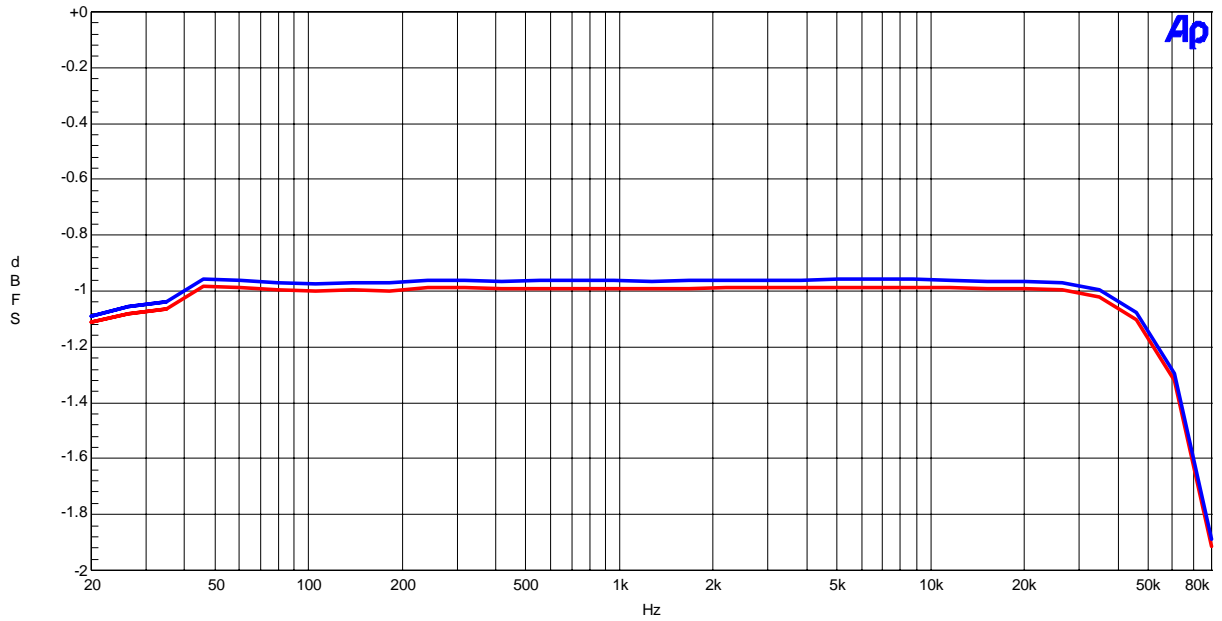

Figure 26. Frequency Response

AKM

AK4556 ADC Crosstalk
fs=192kHz

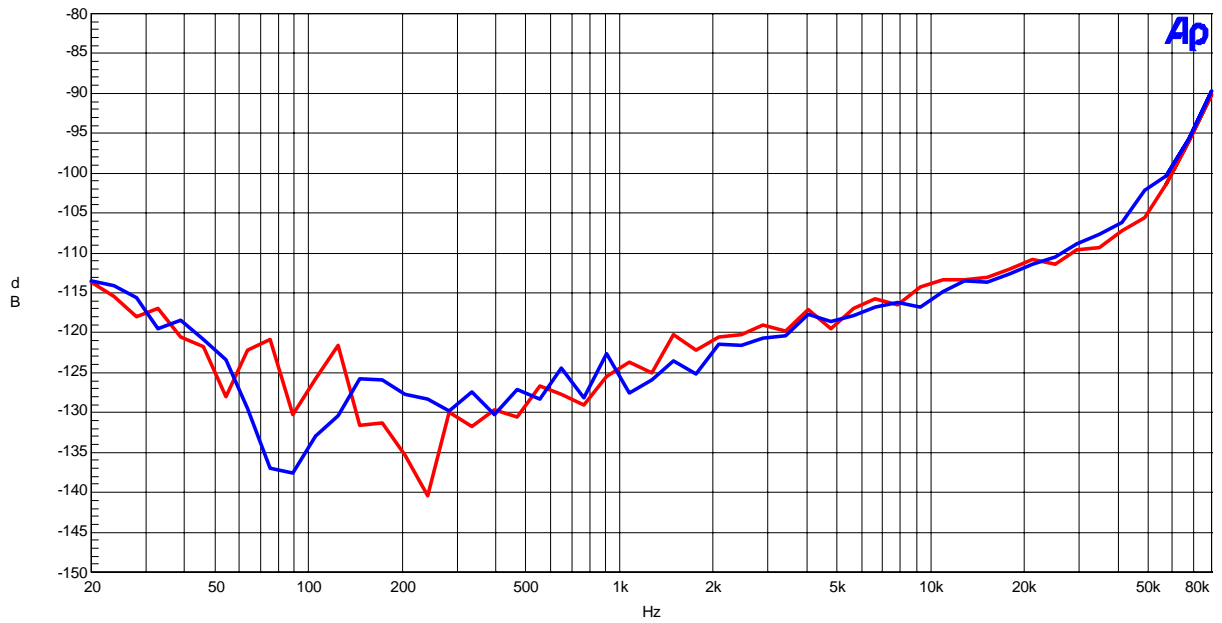

Figure 27. Crosstalk

DAC

fs=48kHz

AKM

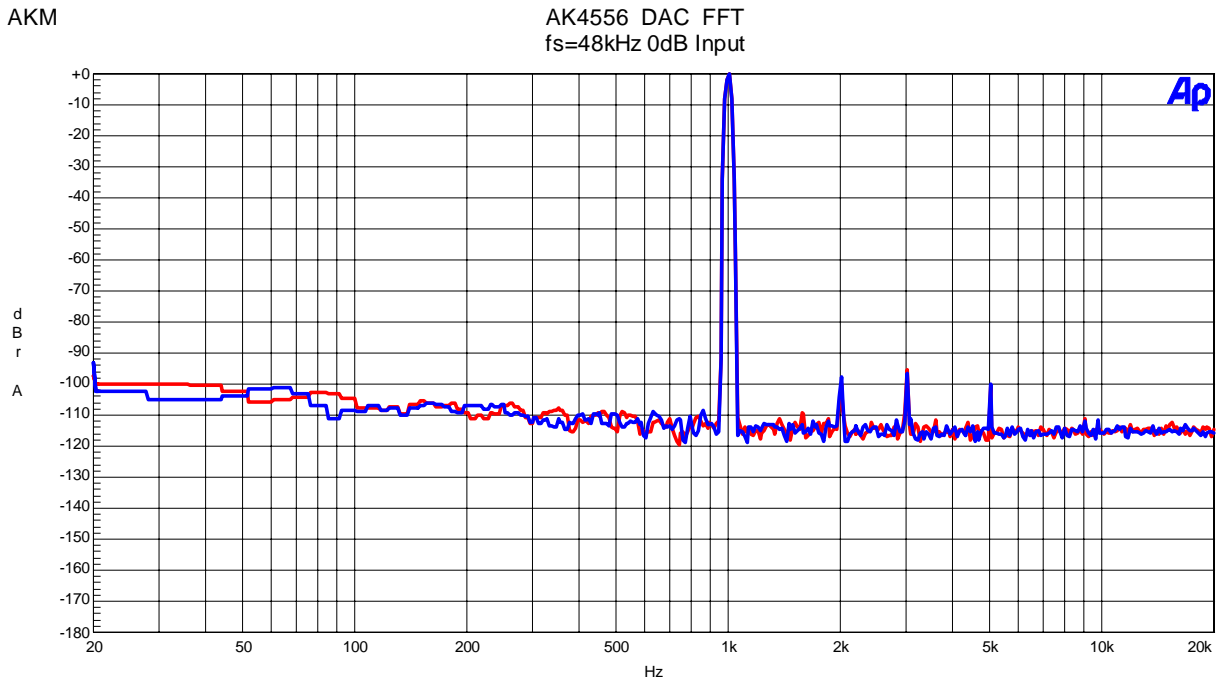

Figure 28. FFT (fin=1kHz , Input Level=0dBFS)

AKM

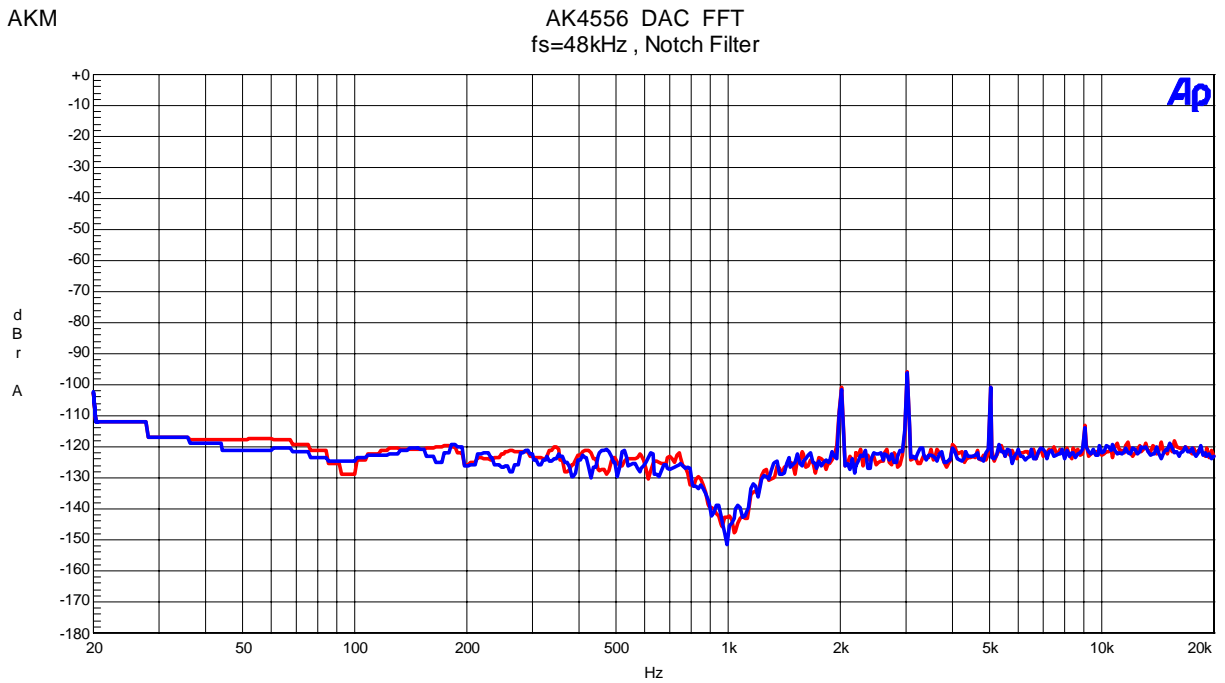

Figure 29. FFT (fin=1kHz , Input Level=0dBFS , Notch Filter)

AKM

AK4556 DAC FFT
fs=48kHz , -60dB Input

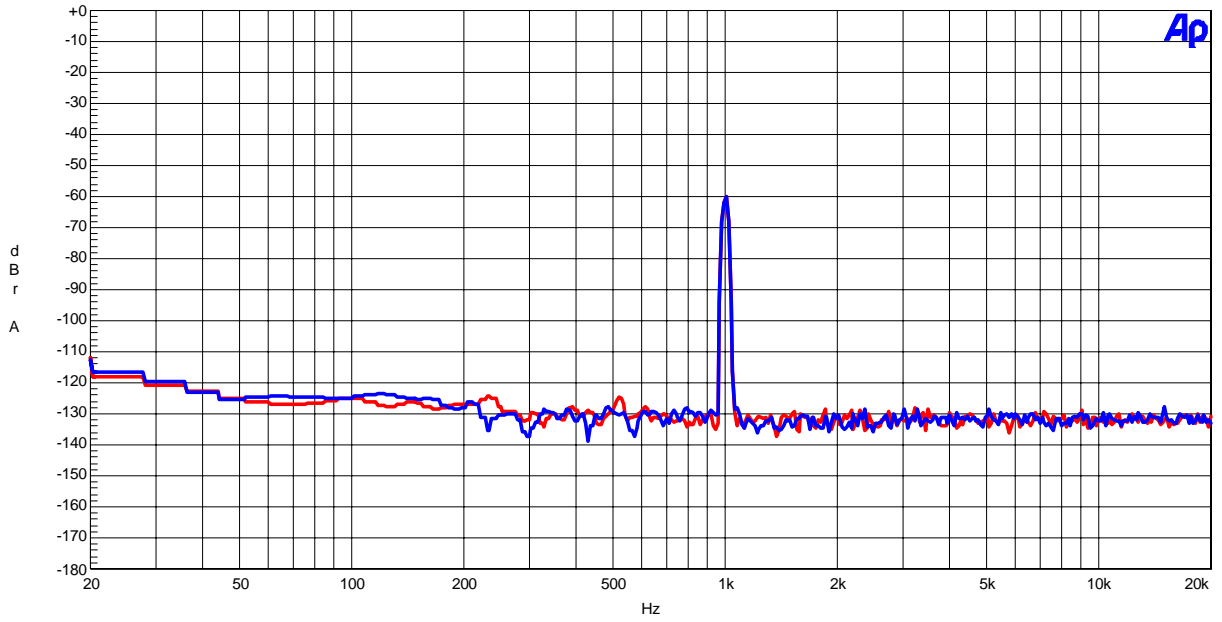

Figure 30. FFT (fin=1kHz , Input Level=-60dBFS)

AKM

AK4556 DAC FFT
fs=48kHz , No Signal

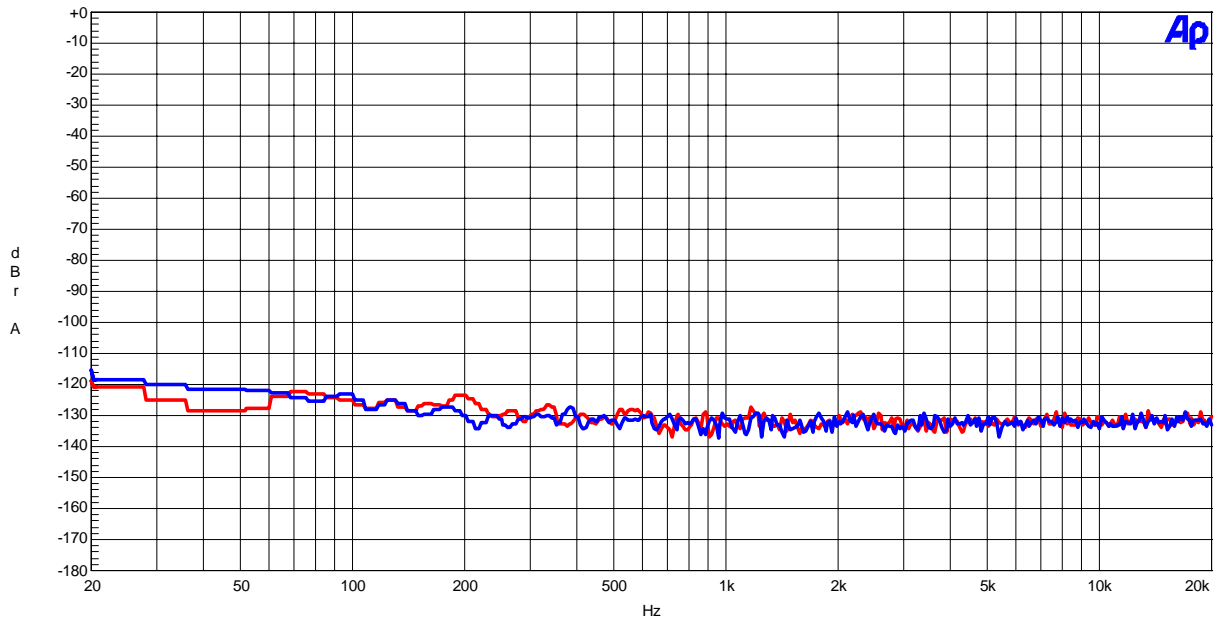

Figure 31. FFT (fin=1kHz , No Signal)

AKM

AK4556 DAC THD + N vs Input Level
fs=48kHz

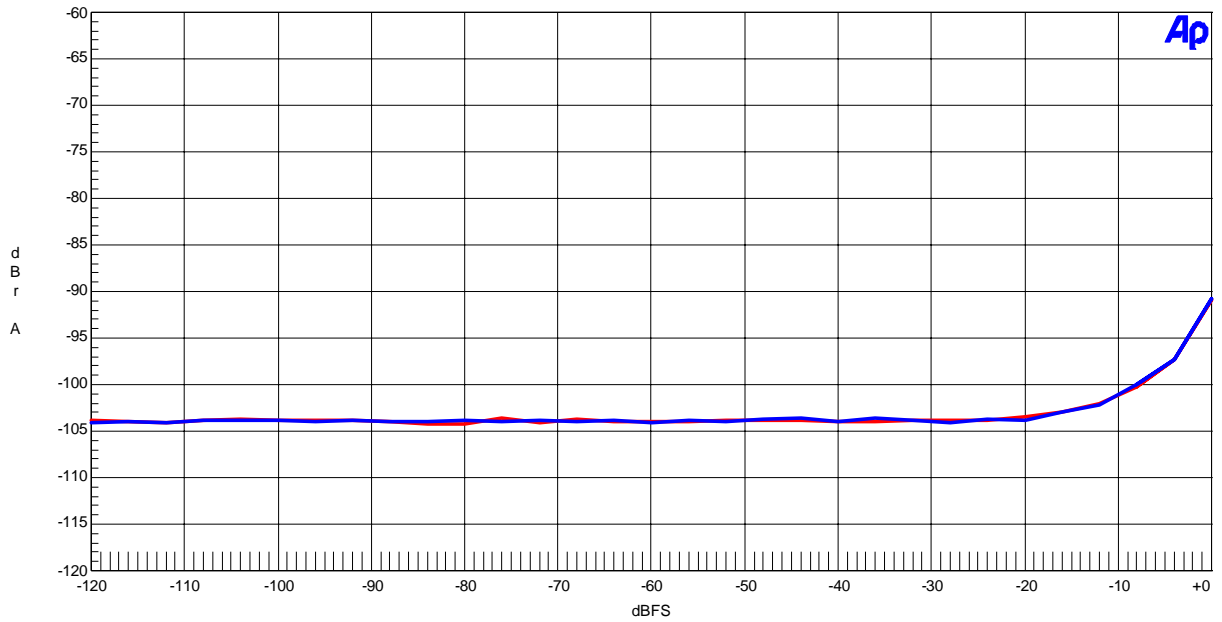

Figure 32. THD+N vs Input Level (fin=1kHz)

AKM

AK4556 DAC THD + N vs Input Frequency
fs=48kHz

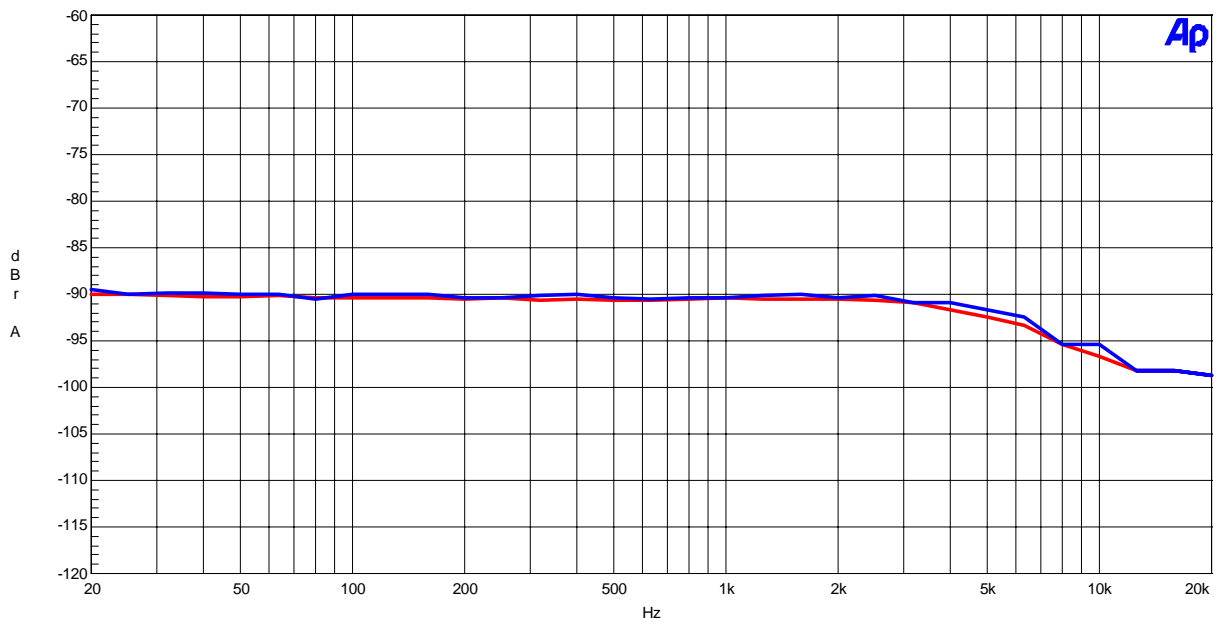

Figure 33. THD+N vs Input Frequency (Input Level =0dBFS)

AKM

AK4556 DAC Linearity
fs=48kHz

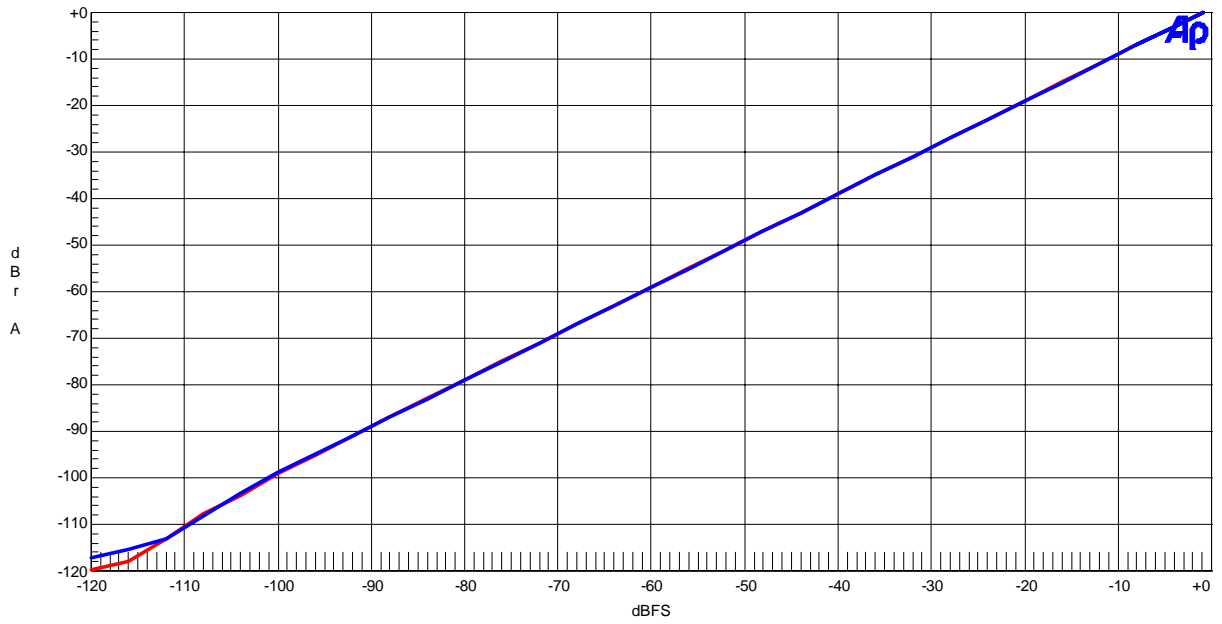

Figure 34. Linearity (fin=1kHz)

AKM

AK4556 DAC Frequency Response
fs=48kHz

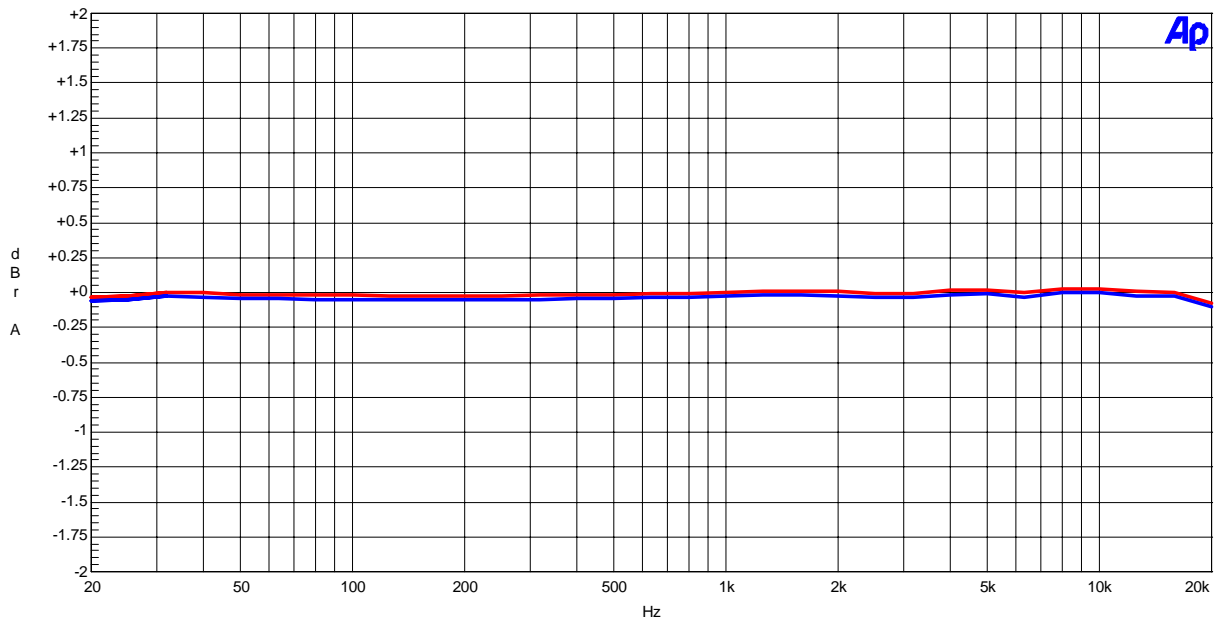

Figure 35. Frequency Response

AKM

AK4556 DAC Crosstalk
fs=48kHz

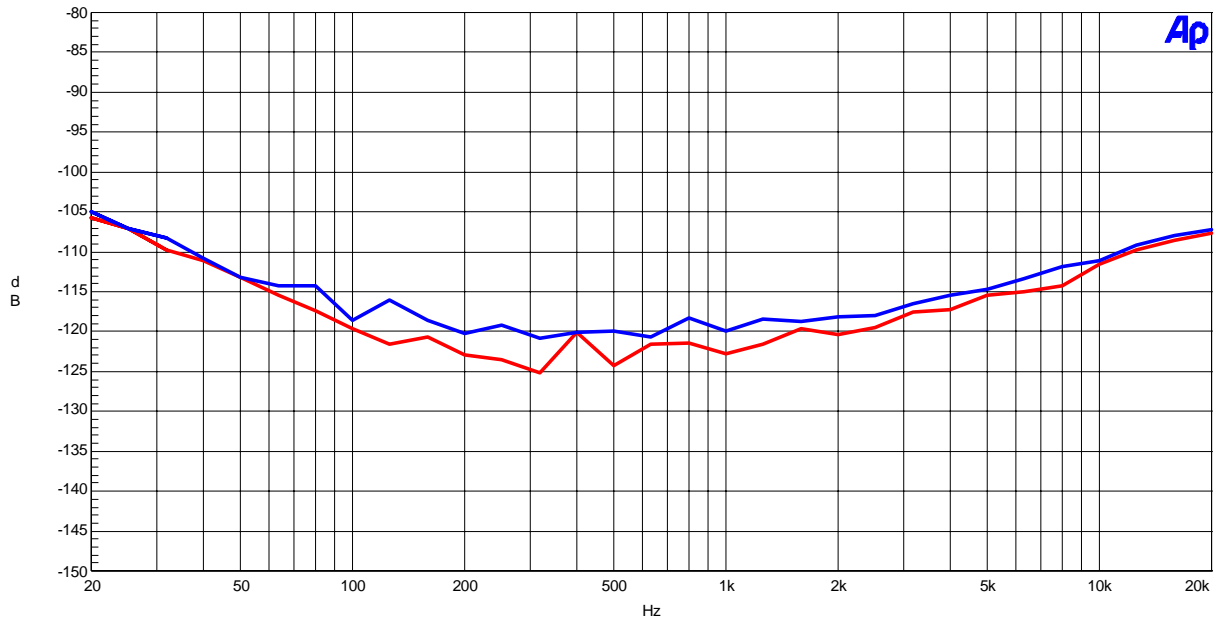

Figure 36. Crosstalk

fs=96kHz

AKM

AK4556 DAC FFT
fs=96kHz , 0dB Input

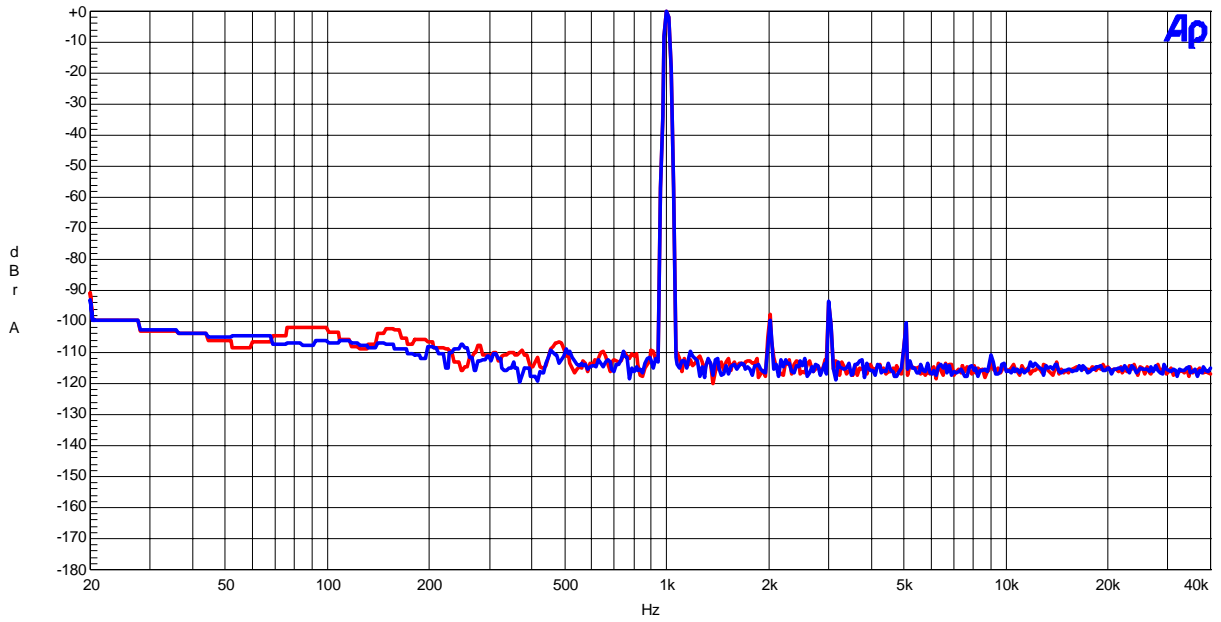

Figure 37. FFT (fin=1kHz , Input Level=0dBFS)

AKM

AK4556 DAC FFT
fs=96kHz , Notch Filter

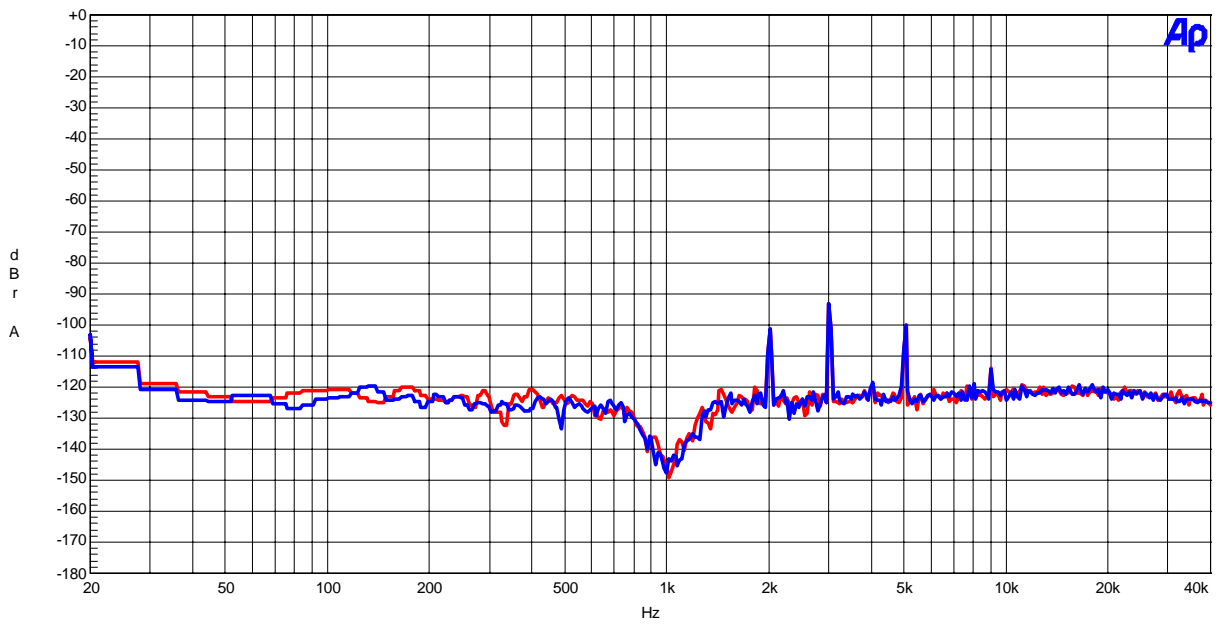

Figure 38. FFT (fin=1kHz , Input Level=0dBFS , Notch Filter)

AKM

AK4556 DAC FFT
fs=96kHz , -60dB Input

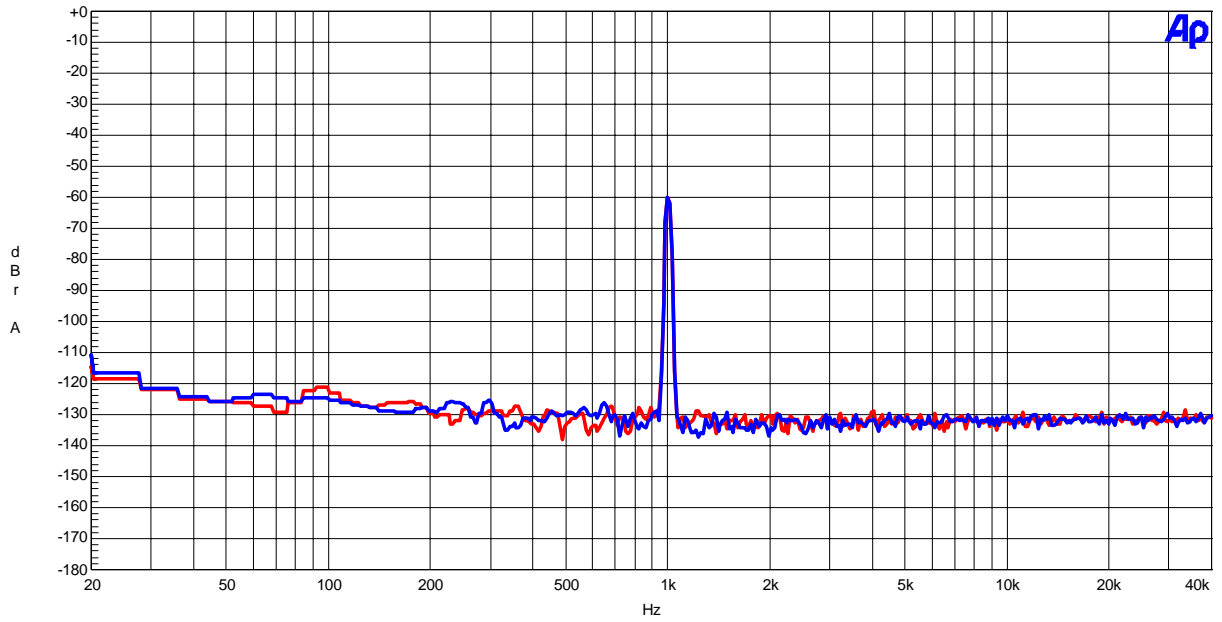

Figure 39. FFT (fin=1kHz , Input Level=-60dBFS)

AKM

AK4556 DAC FFT
fs=96kHz , No Signal

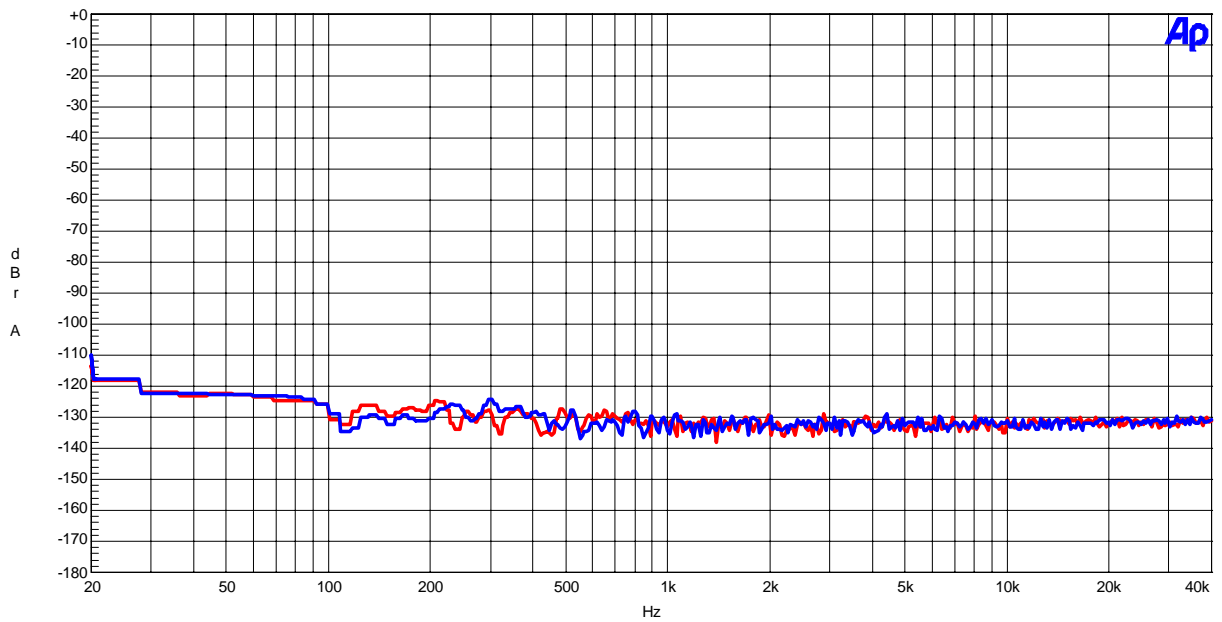

Figure 40. FFT (fin=1kHz , No Signal)

AKM

AK4556 DAC THD + N vs Input Level
fs=96kHz

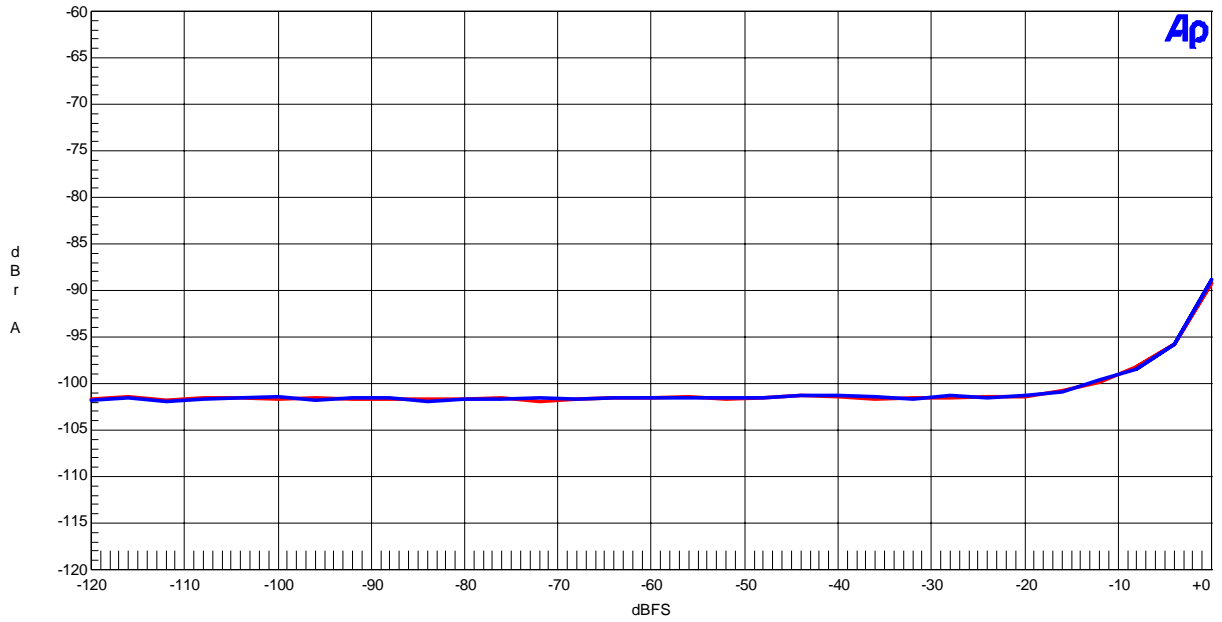

Figure 41. THD+N vs Input Level (fin=1kHz)

AKM

AK4556 DAC THD + N vs Input Frequency
fs=96kHz

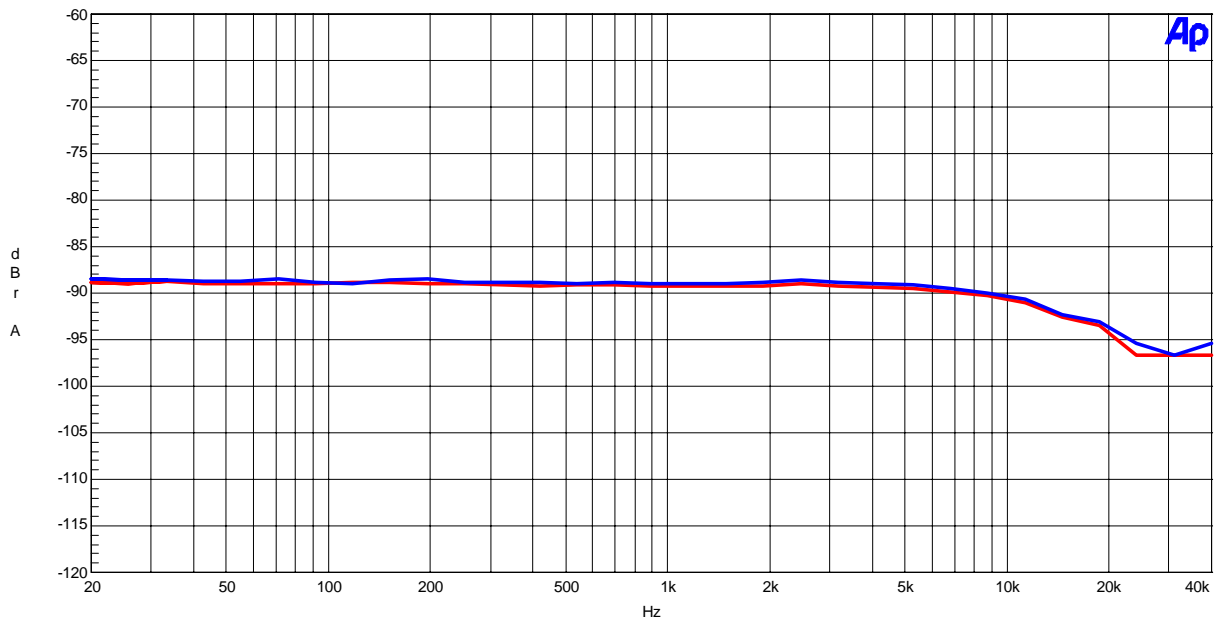

Figure 42. THD+N vs Input Frequency (Input Level =-1dBFS)

AKM

AK4556 DAC Linearity
fs=96kHz

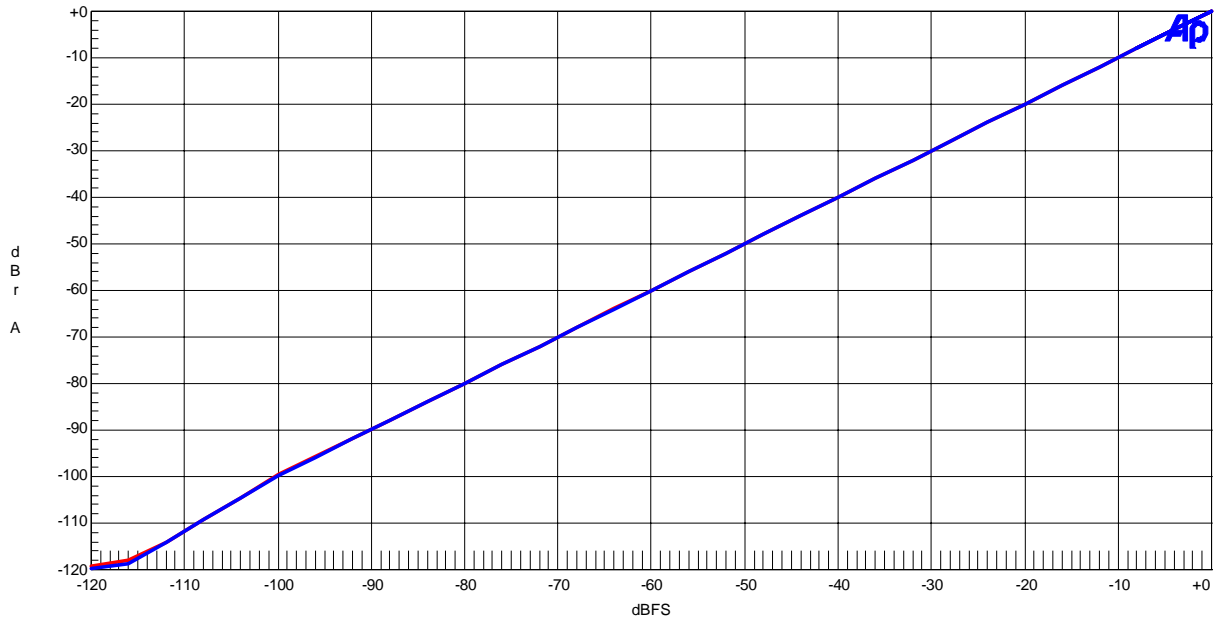

Figure 43. Linearity (fin=1kHz)

AKM

AK4556 DAC Frequency Response
fs=96kHz

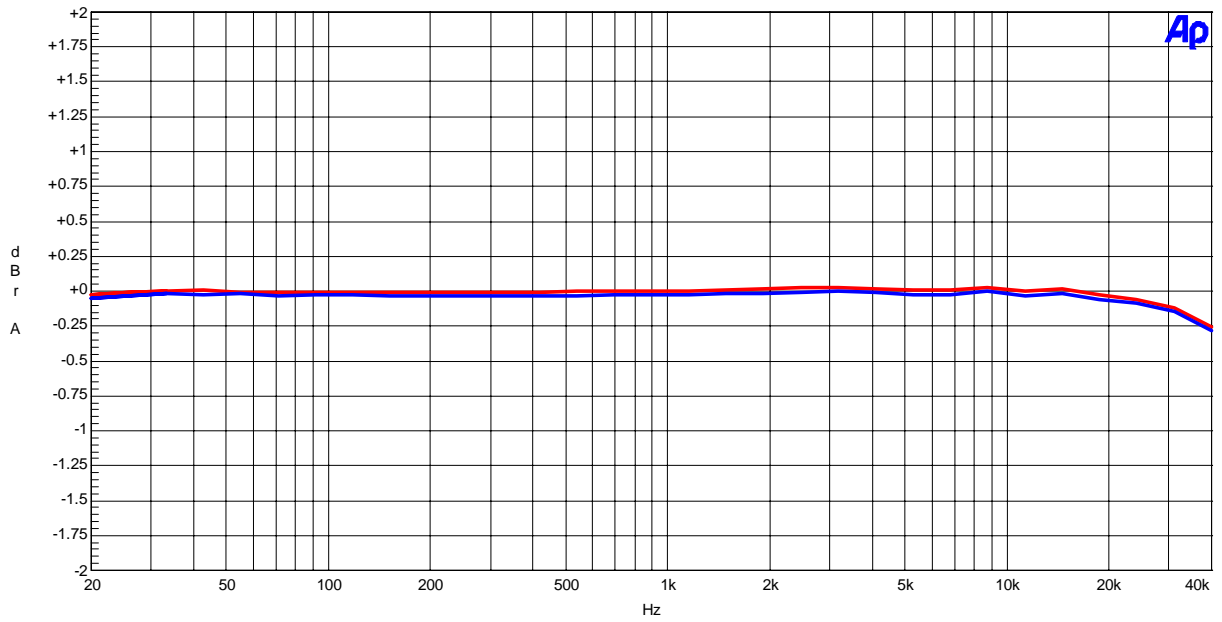

Figure 44. Frequency Response

AKM

AK4556 DAC Crosstalk
fs=96kHz

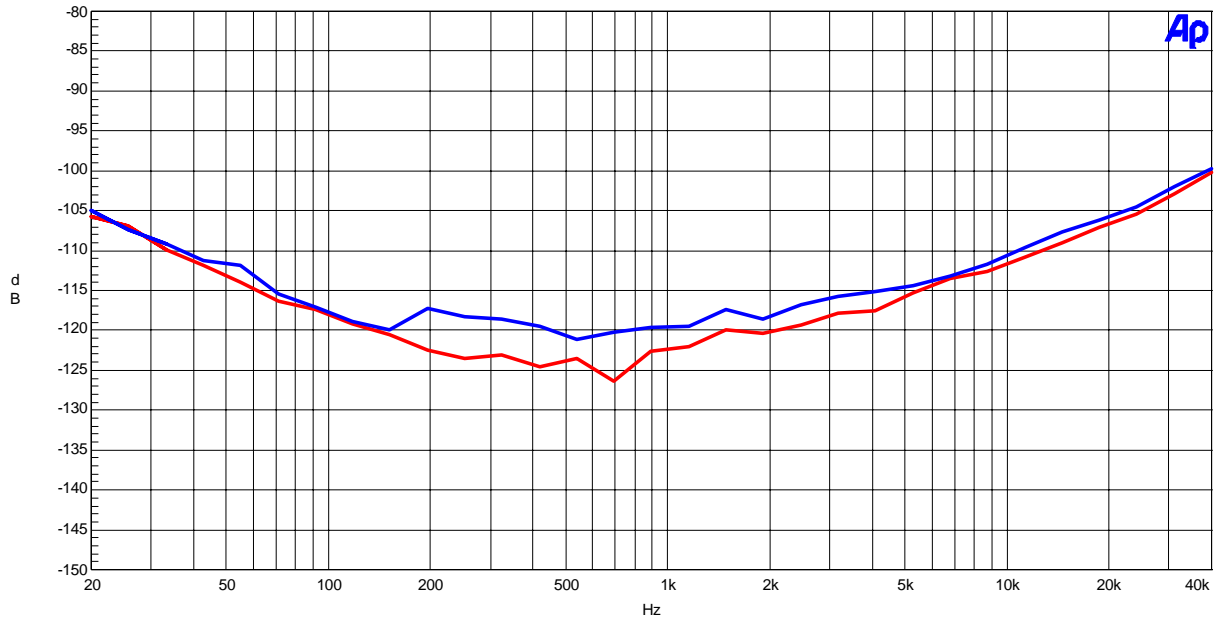

Figure 45. Crosstalk

fs=192kHz

AKM

AK4556 DAC FFT
fs=192kHz , 0dB Input

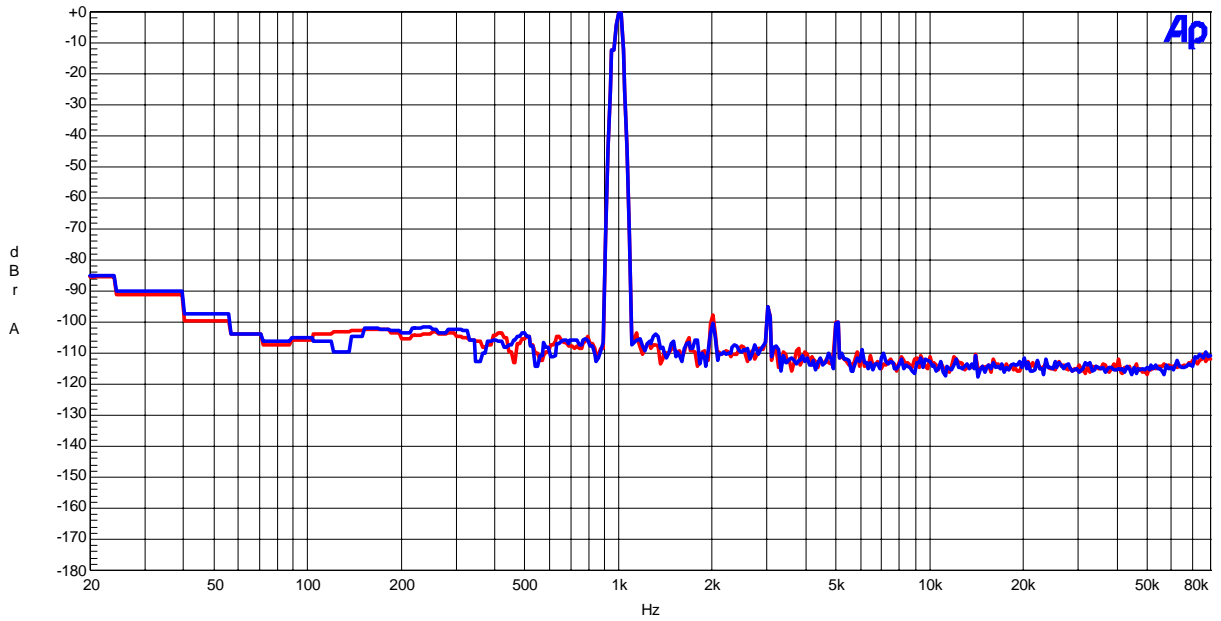

Figure 46. FFT (fin=1kHz , Input Level=0dBFS)

AKM

AK4556 DAC FFT
fs=192kHz , Notch Filter

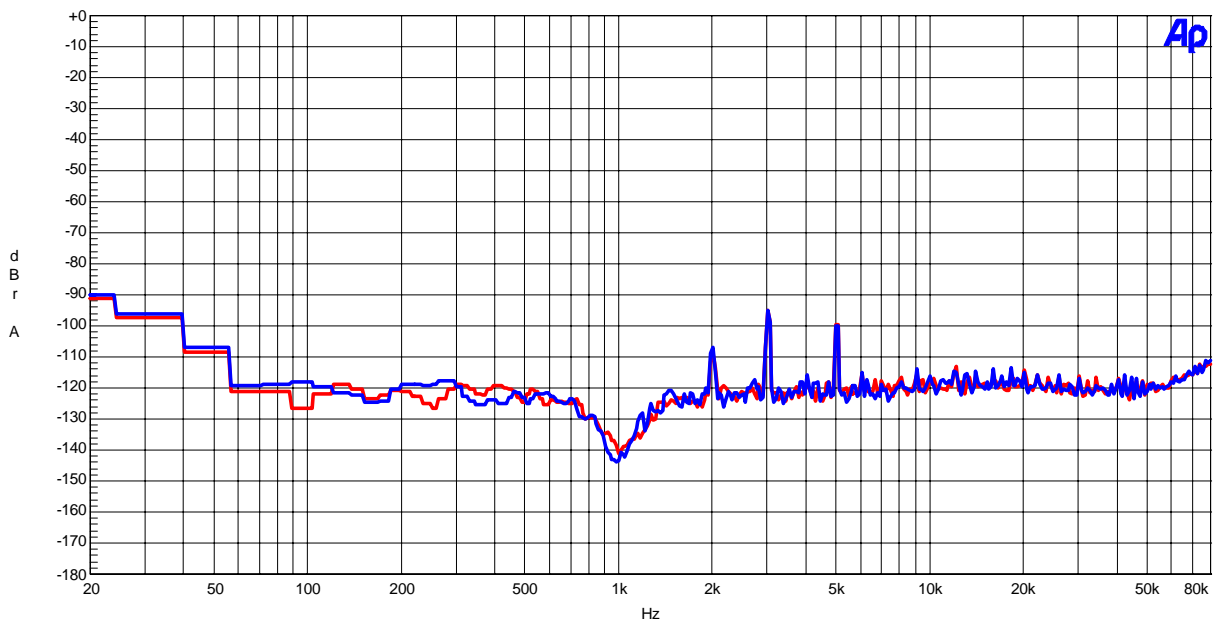

Figure 47. FFT (fin=1kHz , Input Level=0dBFS , Notch Filter)

AKM

AK4556 DAC FFT
fs=192kHz, -60dB Input

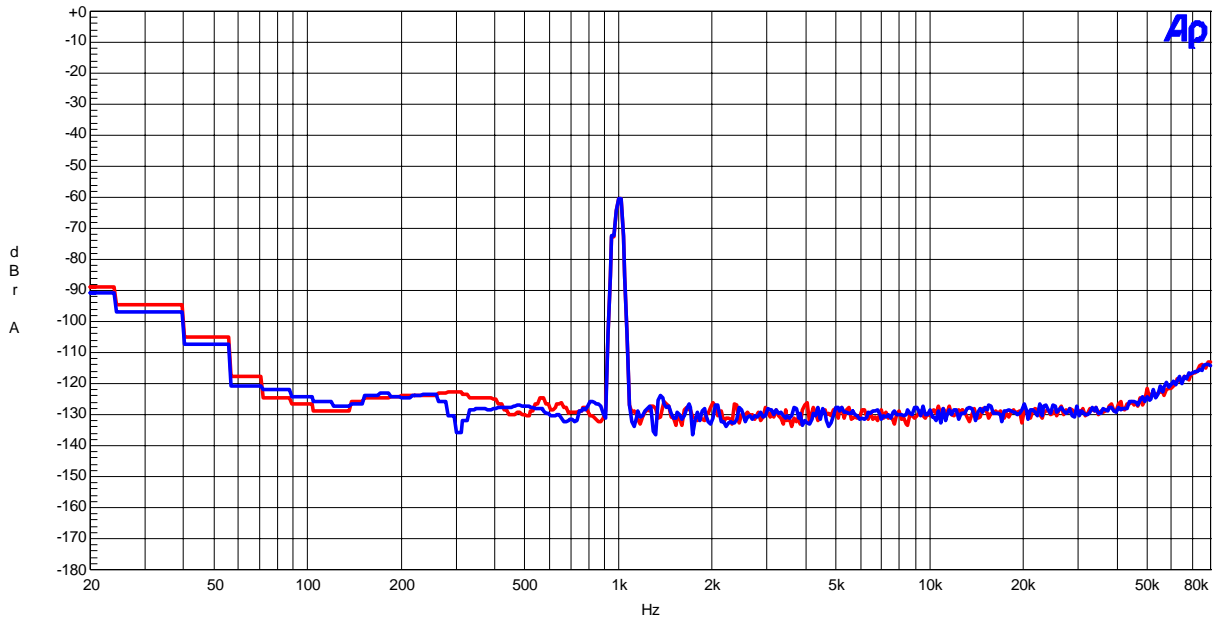

Figure 48. FFT (fin=1kHz, Input Level=-60dBFS)

AKM

AK4556 DAC FFT
fs=192kHz, No Signal

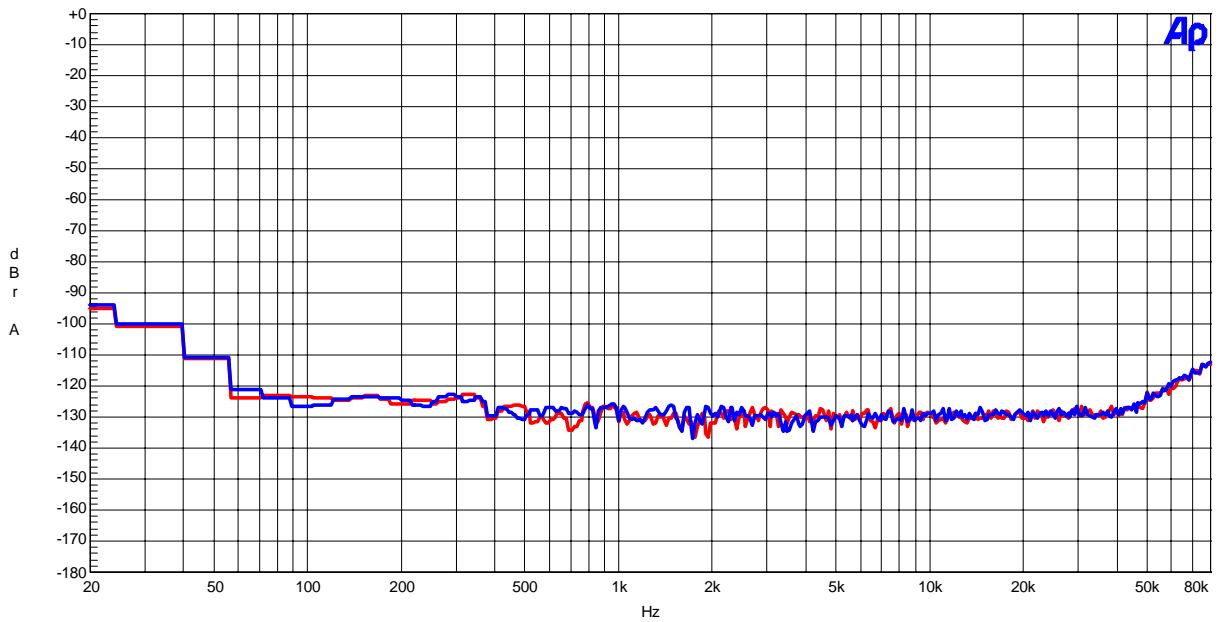

Figure 49. FFT (fin=1kHz, No Signal)

AKM

AK4556 DAC THD + N vs Input Level
fs=192kHz

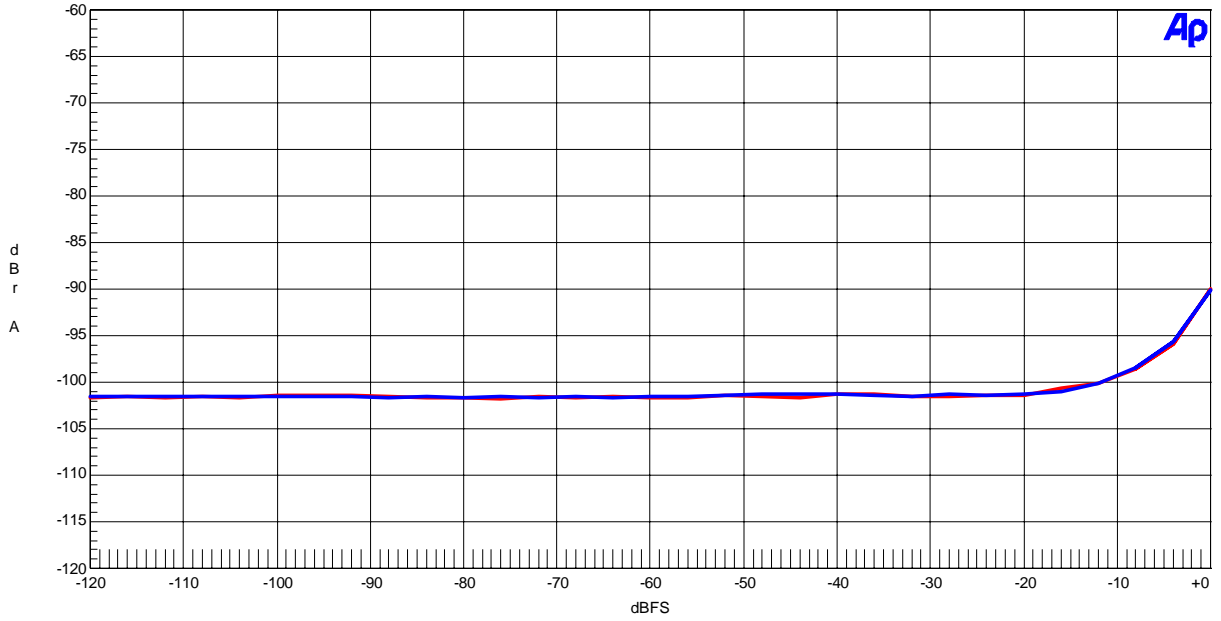

Figure 50. THD+N vs Input Level (fin=1kHz)

AKM

AK4556 DAC THD + N vs Input Frequency
fs=192kHz

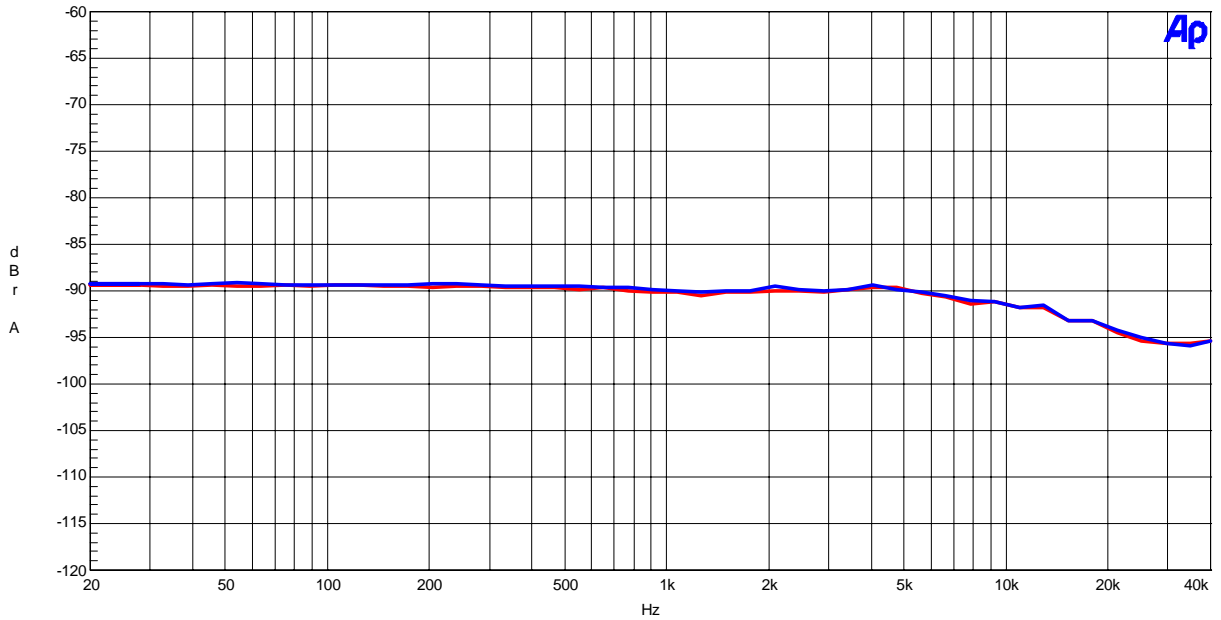

Figure 51. THD+N vs Input Frequency (Input Level =0dBFS)

AKM

AK4556 DAC Linearity
fs=192kHz

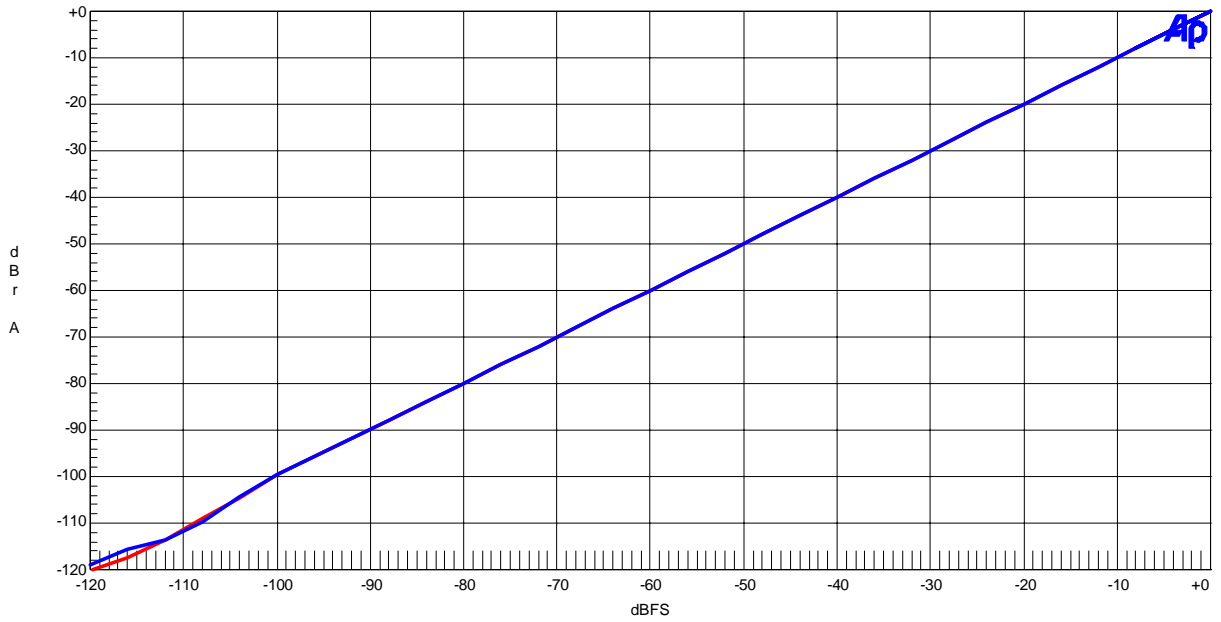

Figure 52. Linearity (fin=1kHz)

AKM

AK4556 DAC Frequency Response
fs=192kHz

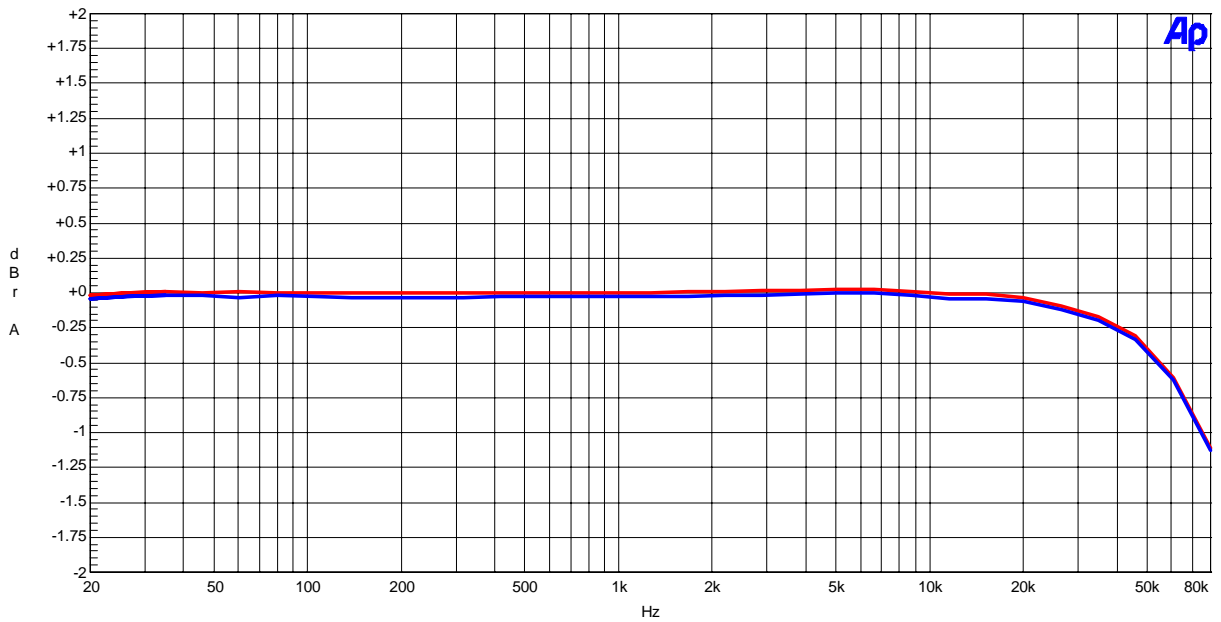

Figure 53. Frequency Response

AKM

AK4556 DAC Crosstalk
fs=192kHz

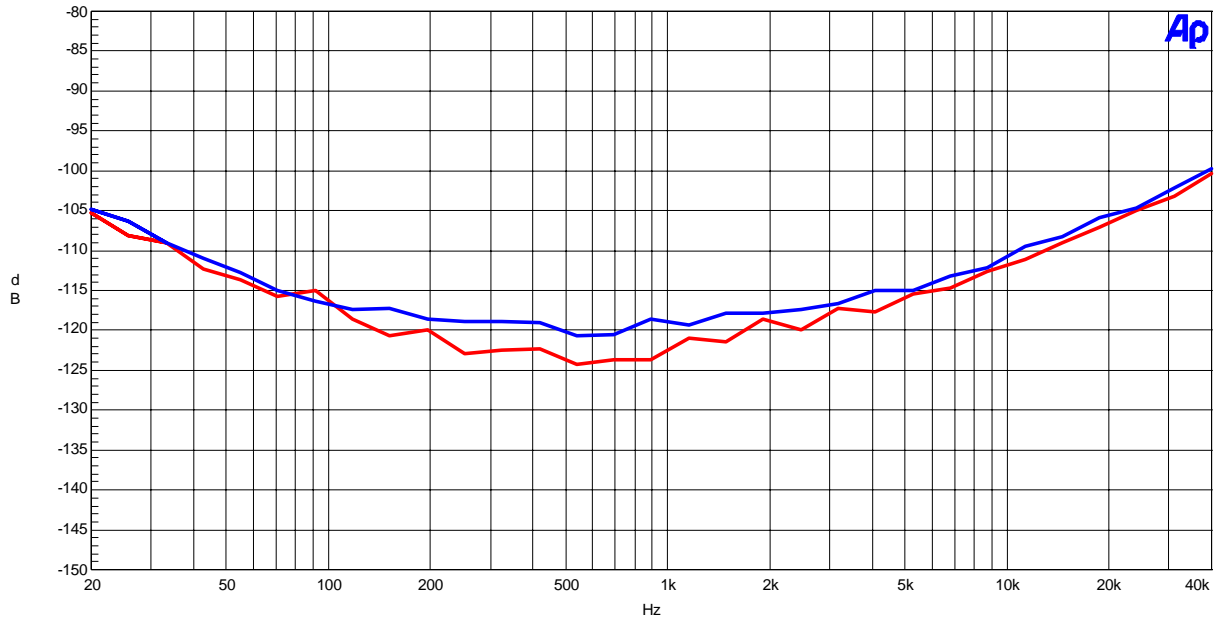

Figure 54. Crosstalk

Revision History

Date (YY/MM/DD)	Manual Revision	Board Revision	Reason	Contents
06/05/18	KM082900	0	First Edition	
06/08/25	KM082901	1	Change device revision	<ul style="list-style-type: none"> • AK4556 Rev.A → Rev.B • Table Data & Plot Data were updated.

IMPORTANT NOTICE

- These products and their specifications are subject to change without notice. Before considering any use or application, consult the Asahi Kasei Microsystems Co., Ltd. (AKM) sales office or authorized distributor concerning their current status.
- AKM assumes no liability for infringement of any patent, intellectual property, or other right in the application or use of any information contained herein.
- Any export of these products, or devices or systems containing them, may require an export license or other official approval under the law and regulations of the country of export pertaining to customs and tariffs, currency exchange, or strategic materials.
- AKM products are neither intended nor authorized for use as critical components in any safety, life support, or other hazard related device or system, and AKM assumes no responsibility relating to any such use, except with the express written consent of the Representative Director of AKM. As used here:
 - (a) A hazard related device or system is one designed or intended for life support or maintenance of safety or for applications in medicine, aerospace, nuclear energy, or other fields, in which its failure to function or perform may reasonably be expected to result in loss of life or in significant injury or damage to person or property.
 - (b) A critical component is one whose failure to function or perform may reasonably be expected to result, whether directly or indirectly, in the loss of the safety or effectiveness of the device or system containing it, and which must therefore meet very high standards of performance and reliability.
- It is the responsibility of the buyer or distributor of an AKM product who distributes, disposes of, or otherwise places the product with a third party to notify that party in advance of the above content and conditions, and the buyer or distributor agrees to assume any and all responsibility and liability for and hold AKM harmless from any and all claims arising from the use of said product in the absence of such notification.

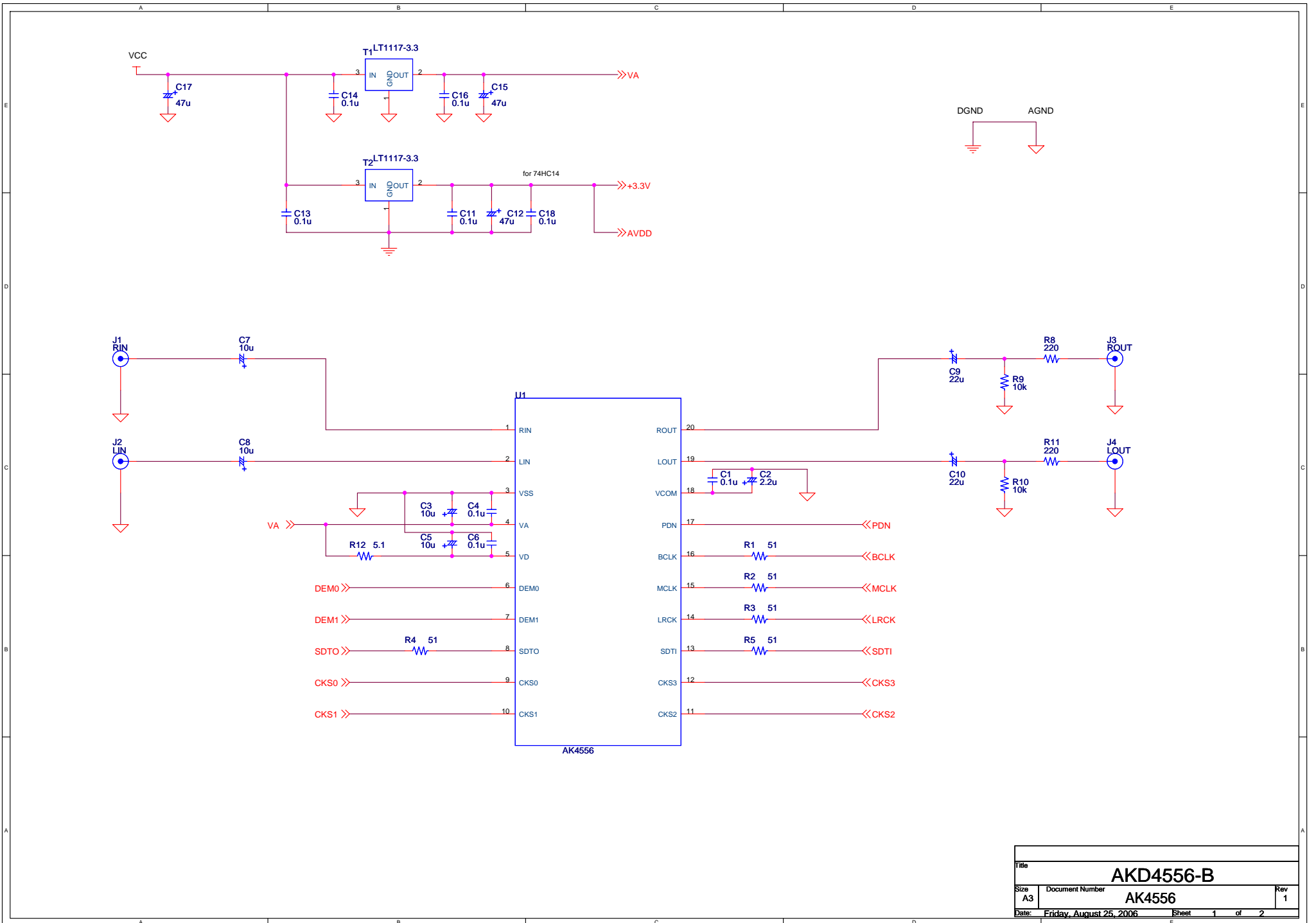

Title			AKD4556-B	
Size	Document Number			Rev
A3	AK4556			1
Date:	Friday, August 25, 2006	Sheet	1	of 2

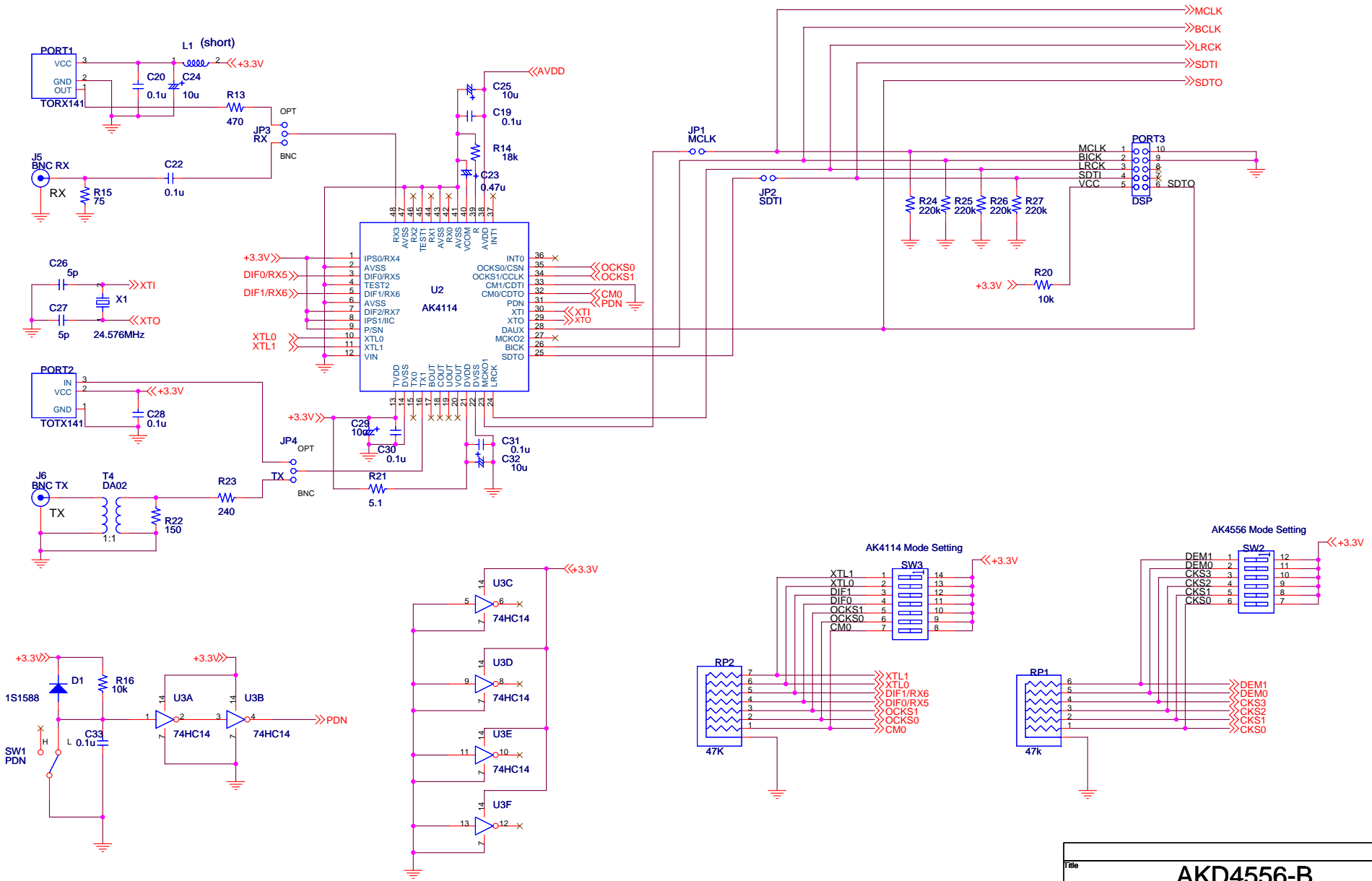

Title			
AKD4556-B			
Size	Document Number	Rev	
A3		1	
Date:	Friday, August 25, 2006	Sheet	2 of 2

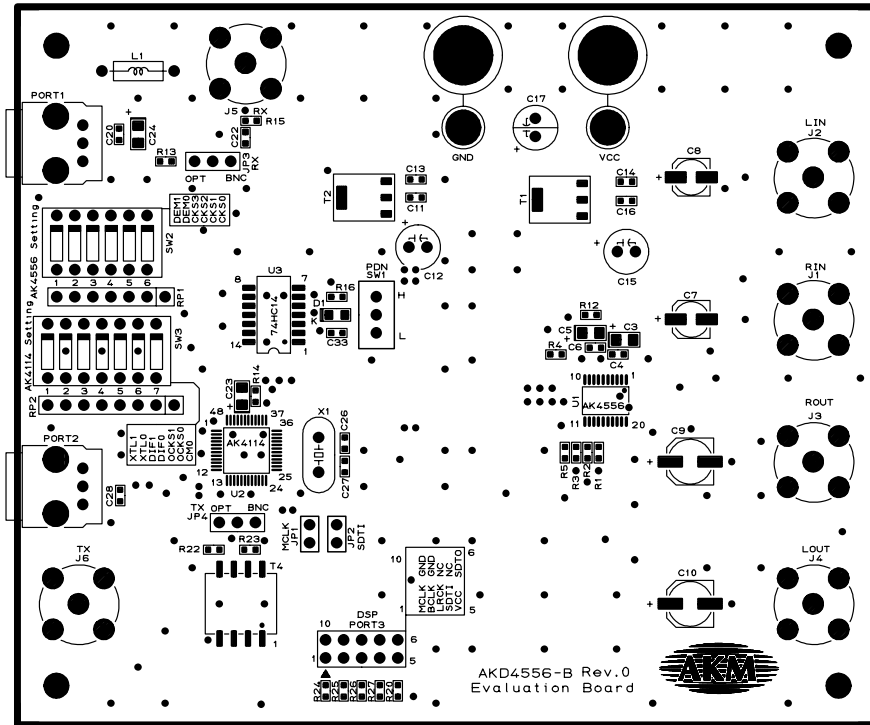

AKD4556-B L1 SILK

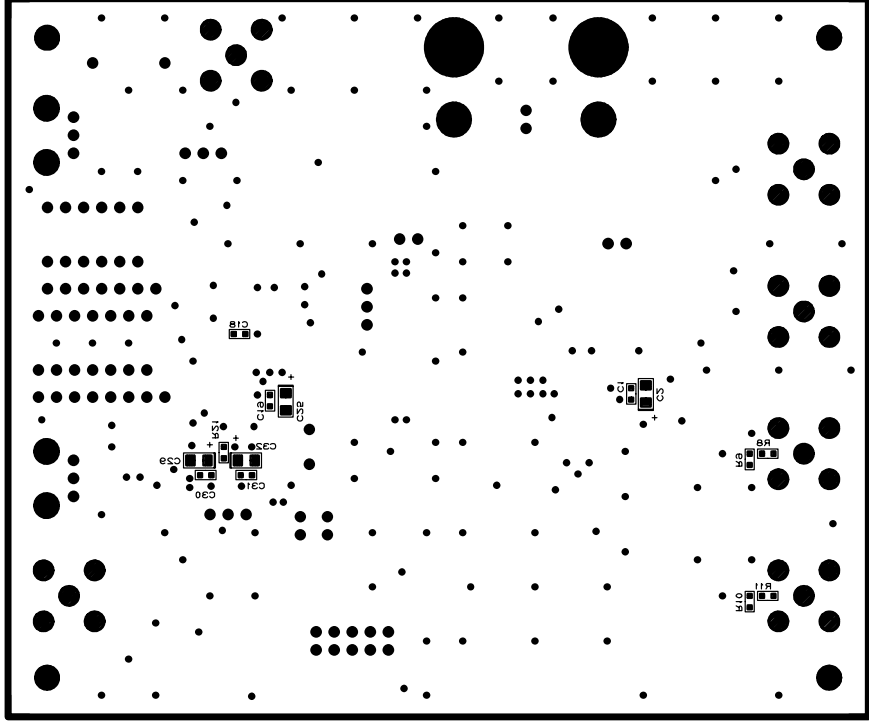

AKD422E-B LZ SILK

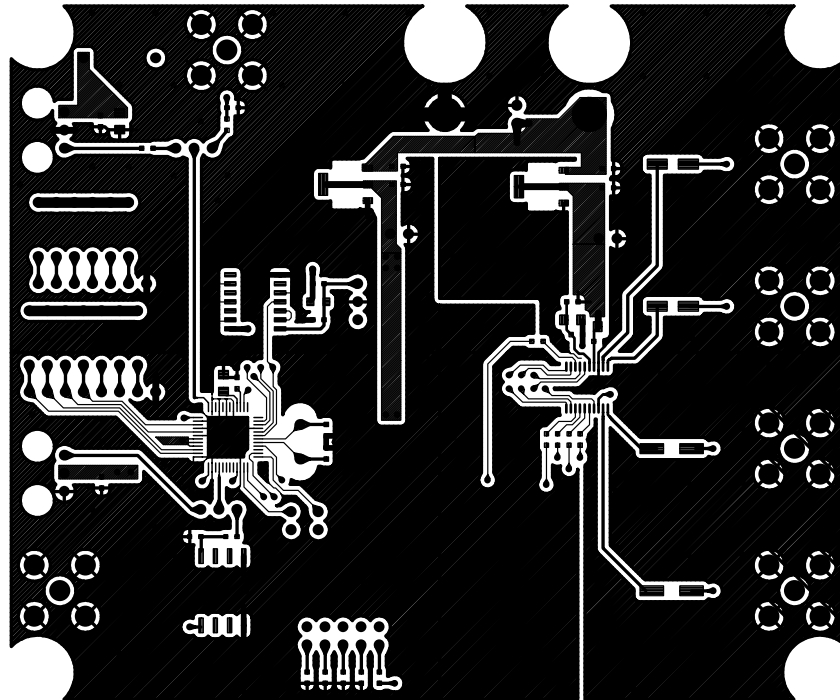

AKD4556-B L1

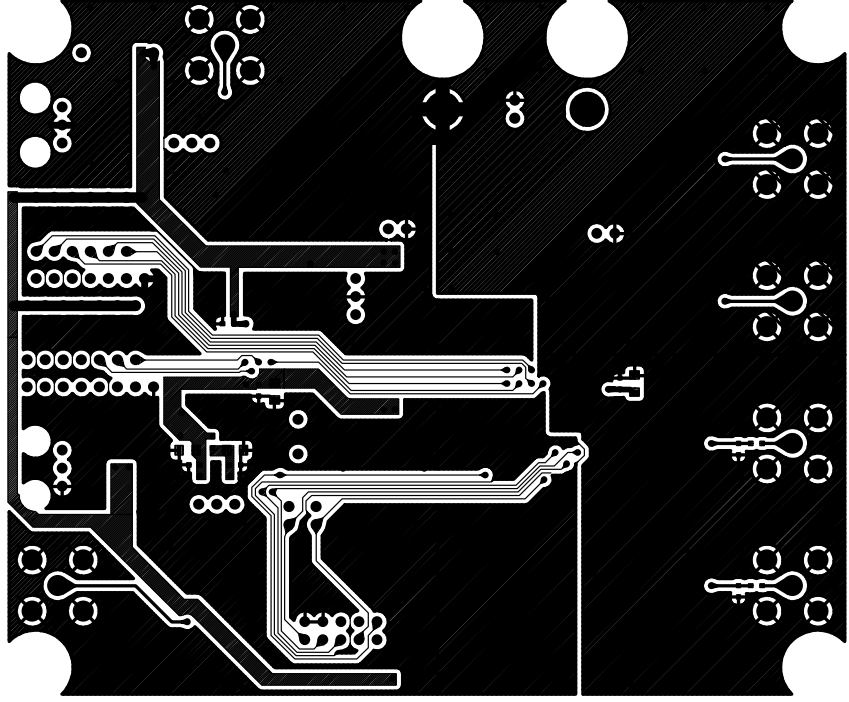

AKD422E-B LS