

**= Preliminary =****AK2559****2ch Cathode Common LDD with Digital APC****1. General Description**

The AK2559 is a 2-channel cathode common LDD (Laser Diode Driver) suitable for MFPs (Multi Function Printer) and LBPs (Laser Beam Printer). The AK2559 equips a 200MHz [Max.] LDD that switches the LD current, current-DACs that set the operation current of LD and a feed-back digital APC (Auto Power Control) circuit that maintains the optical LD power constant. The AK2559 can improve the printing quality and reduces external parts and the cost with useful functions such as the internal APC adjustment, BIAS\_APC (Auto "Ibias" Setting), LD Power Attenuation and Shading Correction with digital interface achieving with the internal arithmetic circuits. Multiple AK2559s can be connected to the multi-beams LD ( $\geq 4$  beams).

**2. Features**

- 2ch Cathode Common LDD Switching LD Current at 200MHz [Max]
- 9-bit Current-DAC for "Ibias": Maximum Output Current = 45mA [Typ.]
- 9-bit Current-DAC for "Isw" with AGC (Auto Gain Control): Maximum Output Current = 90mA [Typ.]
- Feed-Back Digital APC (APC\_FB) and Internal APC Adjustment Circuit with Digital Interface
- Monitor PD Current Input for 2 Beams LD and Multi-Beams LD (by Cascade Connection)
- "BIAS\_APC" (Auto "Ibias" Setting)
- LD Power Attenuation and Shading Correction
- Excessive Over-Current Alarm
- Start-Up Operation (Loading External EEPROM Data and Executing Initial APC)
- Power Supply: 5V $\pm$ 5% Single Power
- Package: 48-pin QFN with Exposed Pad

3. Block Diagram

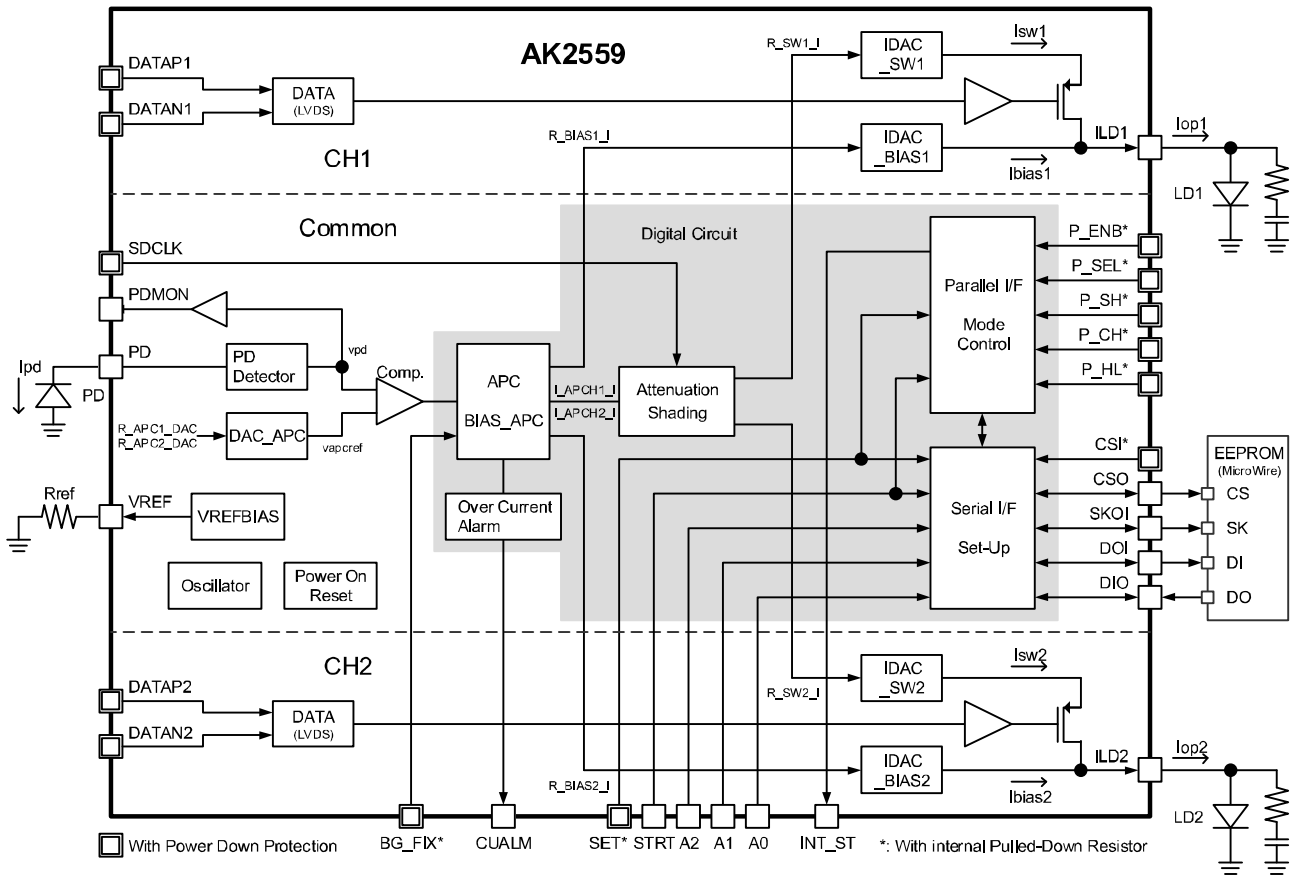
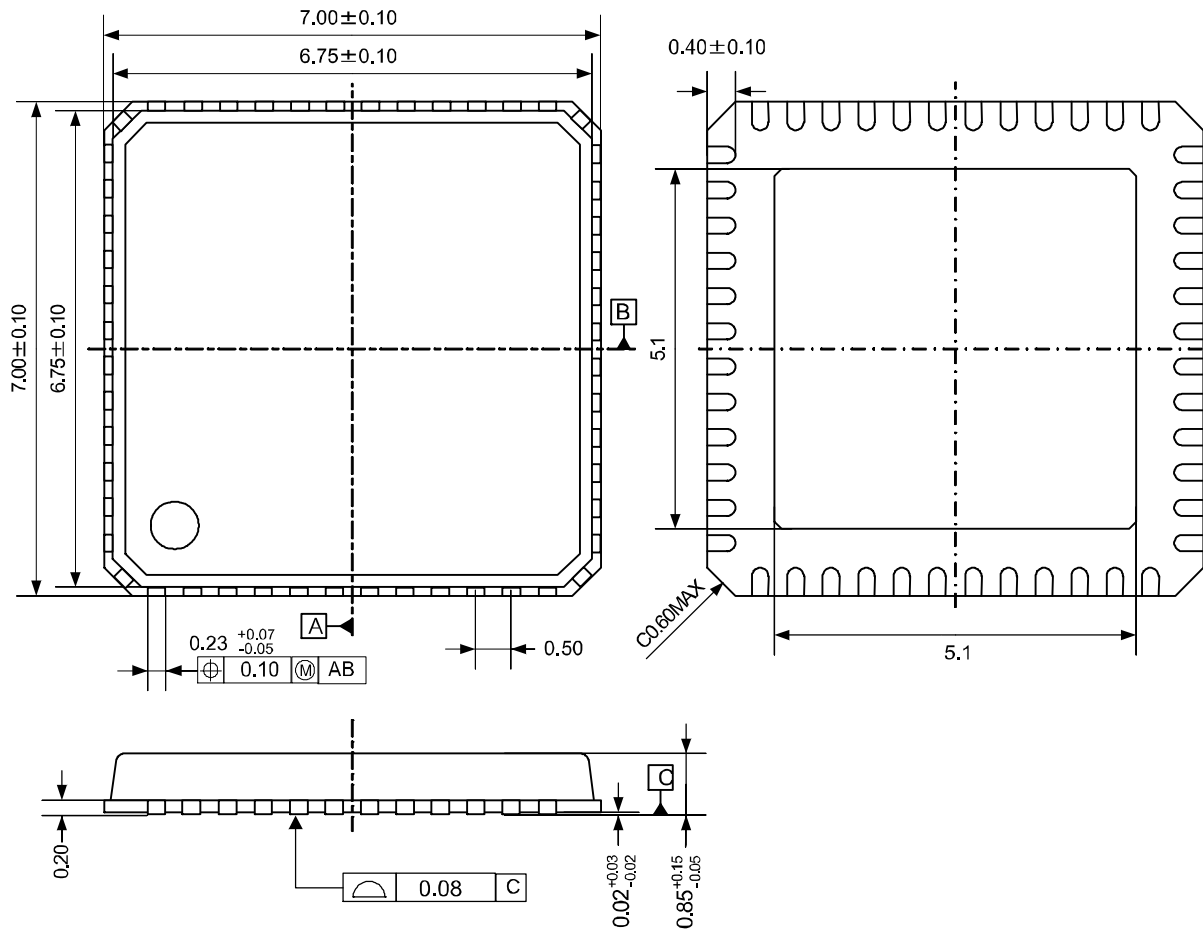

Figure 3.1. AK2559 Block Diagram

**4. Package**

**4.1. Outline Dimensions**



**4.2. Marking**

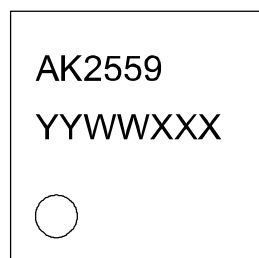

- a. Pin #1 Index: Circle
- b. Marking: AK2559
- c. Date Code: YYWWXXX (7 Digits)
  - YY: Year
  - WW: Week (1 ~ 52)
  - XXX: Manufacturing Identification

**IMPORTANT NOTICE**

0. Asahi Kasei Microdevices Corporation ("AKM") reserves the right to make changes to the information contained in this document without notice. When you consider any use or application of AKM product stipulated in this document ("Product"), please make inquiries the sales office of AKM or authorized distributors as to current status of the Products.
1. All information included in this document are provided only to illustrate the operation and application examples of AKM Products. AKM neither makes warranties or representations with respect to the accuracy or completeness of the information contained in this document nor grants any license to any intellectual property rights or any other rights of AKM or any third party with respect to the information in this document. You are fully responsible for use of such information contained in this document in your product design or applications. **AKM ASSUMES NO LIABILITY FOR ANY LOSSES INCURRED BY YOU OR THIRD PARTIES ARISING FROM THE USE OF SUCH INFORMATION IN YOUR PRODUCT DESIGN OR APPLICATIONS.**
2. The Product is neither intended nor warranted for use in equipment or systems that require extraordinarily high levels of quality and/or reliability and/or a malfunction or failure of which may cause loss of human life, bodily injury, serious property damage or serious public impact, including but not limited to, equipment used in nuclear facilities, equipment used in the aerospace industry, medical equipment, equipment used for automobiles, trains, ships and other transportation, traffic signaling equipment, equipment used to control combustions or explosions, safety devices, elevators and escalators, devices related to electric power, and equipment used in finance-related fields. Do not use Product for the above use unless specifically agreed by AKM in writing.
3. Though AKM works continually to improve the Product's quality and reliability, you are responsible for complying with safety standards and for providing adequate designs and safeguards for your hardware, software and systems which minimize risk and avoid situations in which a malfunction or failure of the Product could cause loss of human life, bodily injury or damage to property, including data loss or corruption.
4. Do not use or otherwise make available the Product or related technology or any information contained in this document for any military purposes, including without limitation, for the design, development, use, stockpiling or manufacturing of nuclear, chemical, or biological weapons or missile technology products (mass destruction weapons). When exporting the Products or related technology or any information contained in this document, you should comply with the applicable export control laws and regulations and follow the procedures required by such laws and regulations. The Products and related technology may not be used for or incorporated into any products or systems whose manufacture, use, or sale is prohibited under any applicable domestic or foreign laws or regulations.
5. Please contact AKM sales representative for details as to environmental matters such as the RoHS compatibility of the Product. Please use the Product in compliance with all applicable laws and regulations that regulate the inclusion or use of controlled substances, including without limitation, the EU RoHS Directive. AKM assumes no liability for damages or losses occurring as a result of noncompliance with applicable laws and regulations.
6. Resale of the Product with provisions different from the statement and/or technical features set forth in this document shall immediately void any warranty granted by AKM for the Product and shall not create or extend in any manner whatsoever, any liability of AKM.
7. This document may not be reproduced or duplicated, in any form, in whole or in part, without prior written consent of AKM.